

# Rackmount KVM Console (8 Port / 16 Port) User Manual



[www.kinankvm.com](http://www.kinankvm.com)

@all right reserved Shenzhen Kinan Technology Co., Ltd.

Printing date: 2024/07

Version: V1.4

# Contents

<b>Overview .....</b>	<b>2</b>
Product Description .....	2
Product Features .....	2
Front view .....	3
Structure and Size .....	4
<b>Hardware Installation .....</b>	<b>5</b>
Rack Mounting .....	5
Installation instruction .....	6
<b>Opening the console .....</b>	<b>7</b>
LED Instructions .....	8
LED OSD Configuration .....	9
<b>OSD Operation .....</b>	<b>10</b>
OSD Functions .....	11
F1-ADM .....	12
F2-Scan .....	15
F3-Set .....	16
F4-Tool .....	18
F6-Edit port names .....	19
F7-Set quick view port(QV) .....	19
F8-LOUT .....	19
<b>Appendix.....</b>	<b>20</b>
Specifications (17.3" ) .....	20
FAQ .....	21

## Overview

### Product Description

The KVM console integrates multiple port KVM switches in a 1U height console. It can control multiple computers with a set of device including monitor, keyboard and mouse, thus saves much cost and space to separately equip keyboard, mouse and monitor for every computer.

It is easy and fast to install the KVM console, you just need to connect corresponding cables to the right ports of KVM and its module without software configuration.

The KVM console can control up to 8 or 16 computers, supports multiple hardware platform and multiple operating system.

### Product Features

- 18.5" LED TFT monitor, high brightness, high resolution
- 1U height, suitable height for standard 19" rack mount, metal structure.
- Ultra slim 99 keys US keyboard with small numeric keyboard.
- High resolution and high flexibility with touchpad with two function buttons and scroll wheel.
- A single console controls up to 8/16 DVI computers
- Select computers via push button, hotkey and OSD
- Two level password security--only authorized users view and control computers; up to four users and an administrator with a separate profile for each
- Users can set up different hot keys( **【Scroll Lock】** / **【Caps Lock】** / **【F12】** / **【Ctrl】** ), auto scanning time, port display time, log out time, buzzer on/off and mouse on/off according to their different needs
- Broadcast mode – operations simultaneously performed on all selected computers  
Easily choose servers with mouse
- Multiplatform Support-Compatible with Windows, Sun, Unix and Linux
- Complete keyboard and mouse signal simulation to ensure that the booting and switching are correct
- Auto scan feature for monitoring user-selected computers
- Hot pluggable - add or remove computers without having to power down the switch

Front view

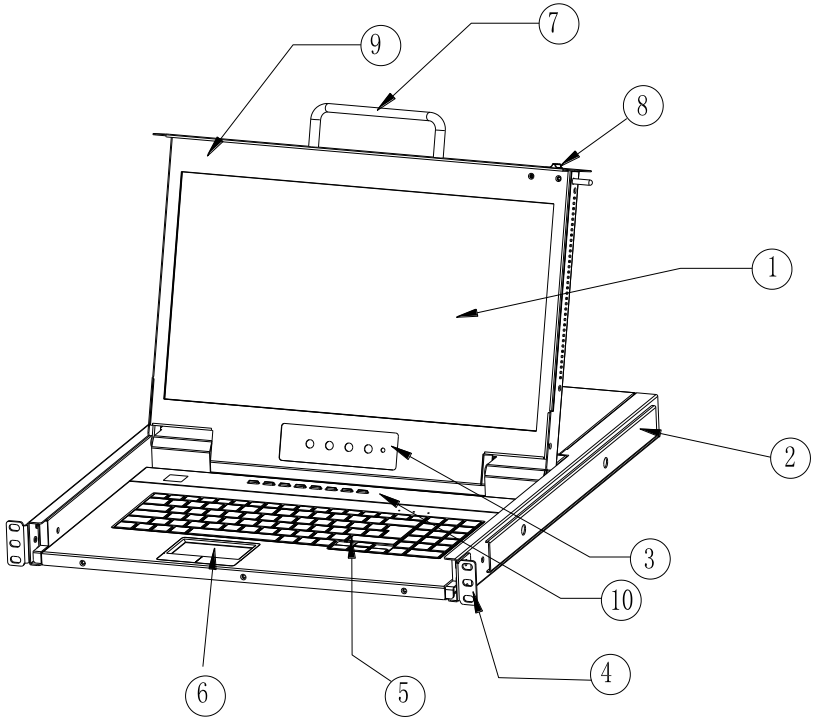

1-1.1 front view

- |                      |                  |
|----------------------|------------------|
| 1. LED Module        | 6. Touchpad      |
| 2. Rear Bracket Slot | 7. Handle        |
| 3. LED OSD Controls  | 8. Release Catch |
| 4. Front Bracket     | 9. Display panel |
| 5. Keyboard          | 10. Switch LED   |

### Structure and Size

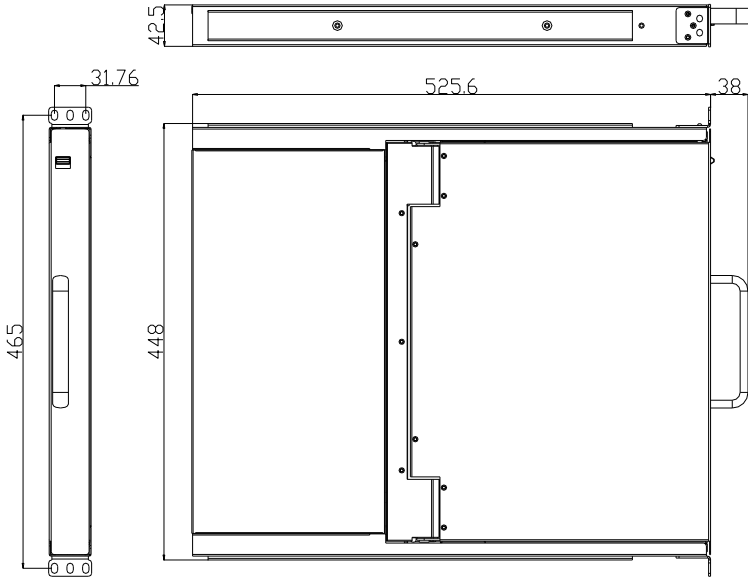

1-1.2

### Back view

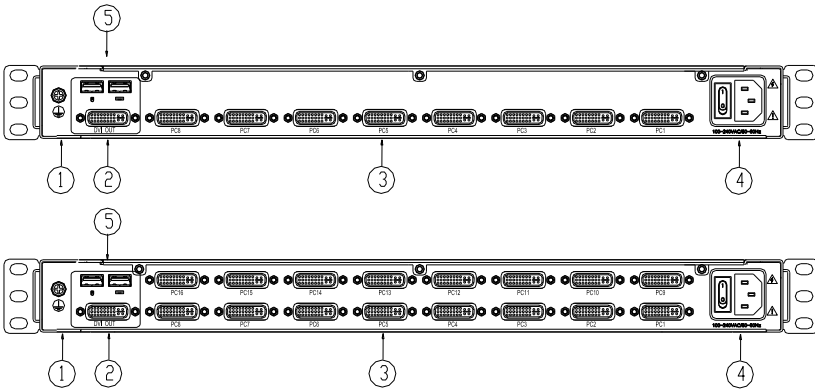

1-1.4

- 1. Ground connection screw
- 2. DVI Output
- 3. KVM port
- 4. Power input (AC)
- 5. USB port

## Hardware Installation

### Rack Mounting

A standard rack mounting kit is provided to mount the switch in a depth of 510-850 mm in a standard 19" rack. For other mounting distance, the rear brackets need to be customized accordingly

With one person hold the switch in place and the other person slides the L bracket into the switch's side mounting brackets from the front to the back, then screws the brackets to the rack. ( see below installation drawing)

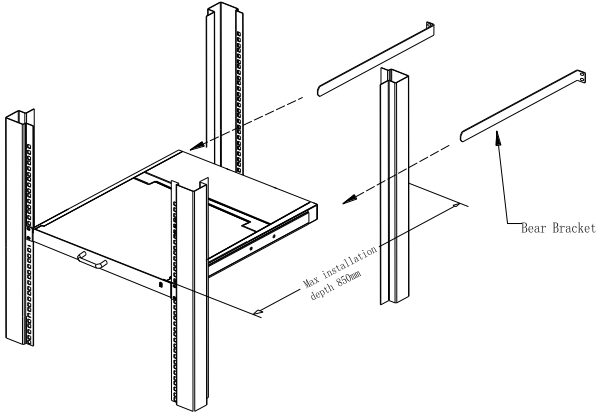

2-1.1 rack mounting (1)

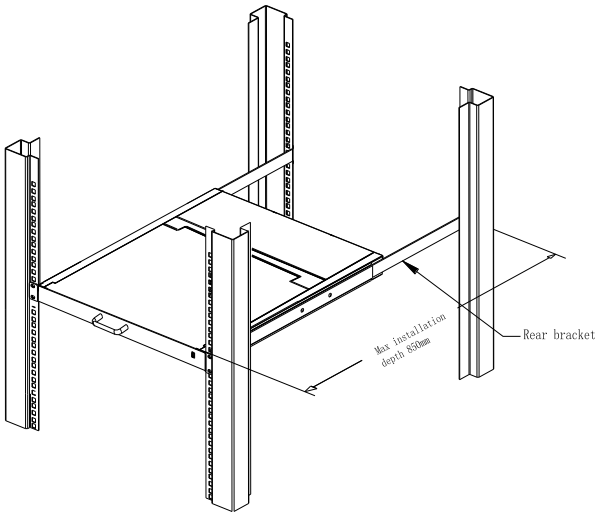

2-1.2 rack mounting (2)

## Installation instruction

- 1) Make sure the rack mounting KVM switch has been connected to the ground (① in the diagram)
- 2) Connect power cable to KVM port as shown in ② in the diagram
- 3) Turn on the power, the KVM start to work after power supply(③ in the diagram)
- 4) Connect KVM switch with the computer according to ④ in the diagram

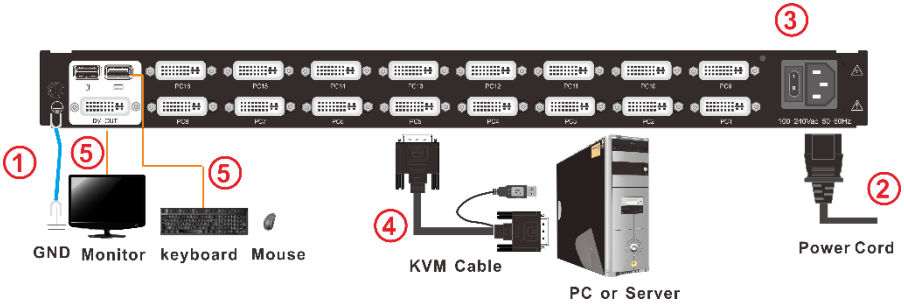

Note: Connect monitor, USB keyboard and mouse to Console port to connect another console (⑤ in the diagram)

*To ensure signal integrity and simplify cable layout, we strongly recommend you using high quality cables with different length.*

## Opening the console

- Release the release catch;

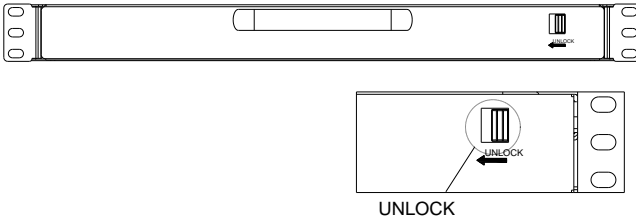

2-1.3 unlocking

**\*Note: The release lock can only do horizontal locking, it can't bear any load.**

- Pull the LED panel all the way out until it clicks into place.
- Rotate the LED module all the way back to expose the LED screen, the LED module can be rotated up to 108°.

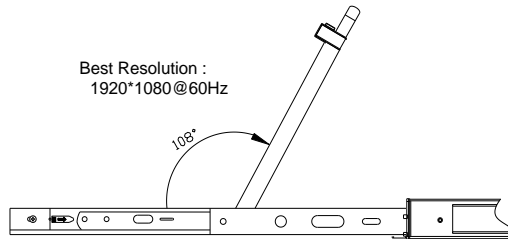

2-1.4 rotate angle of the console

- Turn on power switch, KVM will be issued two "beep" sound, The Port LEDs light flashes 4 times , the LED displays the prompted to enter the user's password.

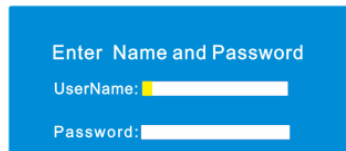

2-1.5 password window

- LED panel is powered on when the power LED is green.
- Power on computer or server after power on KVM and you will see green light at each port.
- The factory default password is blank, it will be OK after double click "Enter".

**NOTE: The username and password are no more than 16 characters, Press and hold the Shift key to type lowercase letters.**

**Please contact the manufacturer for support if the KVM is locked.**



### Closing the console

- Close the LED display panel and the power automatically shut down.
- Push the release catch in the direction of the arrow; push the LED panel all the way in until it automatically locks up.

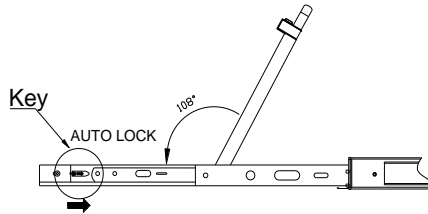
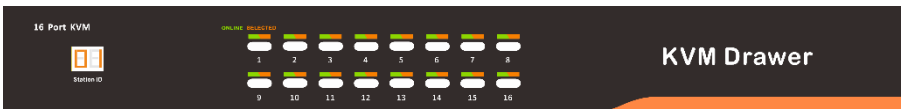

Diagram 2-1.6 unlocking the console

### LED Instructions



3-1.1 front view

No.	Components	Function
1	1-8 or 1-16	Switching freely from port 1 to port 8 /16
2	Port Selection Buttons& LEDs	Indicator LEDs are built into the switches, the online LED light is on the left and the selected LED light is on the right. 1) An online LED light(green) indicates that the KVM has connected to its corresponding computer and power on. 2) A selected LED light(orange) indicates that the computer attached to its corresponding port is up and running.
3	Station ID	Display the current port

Table3-1.1 LED instructions

## LED OSD Configuration



The LED OSD allows you to set up and configure the LED display.

Buttons	Functions
MENU SELECT	Press this button invokes the menu function and brings up the main menu.
EXIT/AUTO	Press this button exits the current menu and return to the previous menu or press this button exits the LED OSD. Press AUTO for automatic configuration.
SL-/SL+	Press this button moves your menu to make corresponding adjustment.
LED state	Green :running Red :power off or access non-standard VESA signal Flash green: energy saving mode or no signal

Table3-1.2 LED OSD configuration instruction

Press AUTO if the screen migrates after power on or under other circumstances, then the screen auto configure to its best display state.(It might can't be adjusted to its best state if part of the display mode is not standard VESA mode, if so return back to OSD menu to RESET, then it will back to normal.

We suggest our customers to set up the display mode at 1920x1080, refresh rate at 60Hz.

## OSD Operation

Double click the right buttons of the mouse or double click hotkey **【Scroll Lock】** to invoke below OSD main menu. You can customize the OSD hotkeys, find more details in OSD function instructions (Page 17).

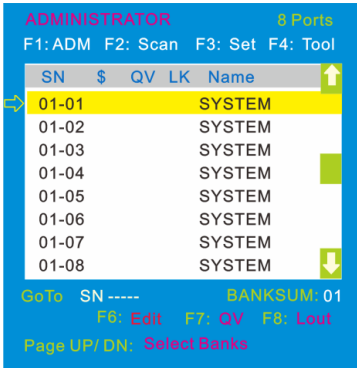

Headings	Explanation
SN	Port number
⇒	It shows the computer port is under monitoring.
\$	The computers are power on and are online
QV	"#": quick view the port "BC": Broadcast port
LK	"@" shows that the port is only available for viewing
Name	Port name, the maximum is 12 bytes

Table 4-1.1: OSD interface

To access the OSD menu through keyboard:

1. In the submenus that appear, moving the highlight bar to your selected port and then press Enter.
2. Press any key from **【0-9】** to enter any port of current station

To access the OSD menu through keyboard:

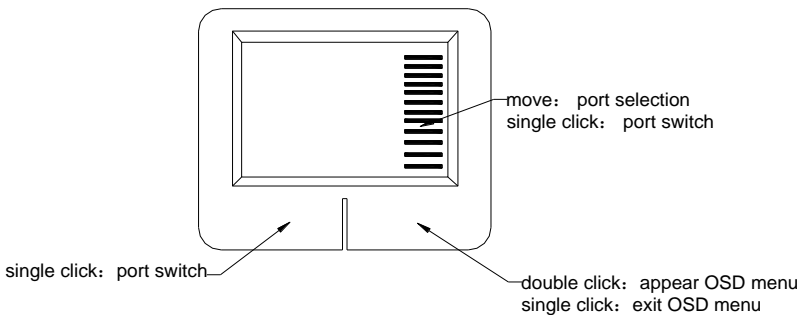

\*Note: Operate via keyboard after invoke the OSD menu via the touchpad.

**OSD Functions**

Menus	Keys	Submenu/explanation
ADM	F1	Set User login: account and password Set accessible: Set access permissions BRC Mode: monitor multiple computers at the same time Load Default: reset the menu to the original factory default settings
Scan	F2	All: Lists all the ports on the installation Power On: lists only powered on ports that have attached computers. Quick View: Lists only the ports that have been selected as Quick View ports
Set	F3	Auto Scan: set scanning time period Port ID: set how long a port displays on the monitor OSD Hotkey: set OSD hotkeys Lout Time off: to set the time out value
Tool	F4	Reset KM: press Enter resets keyboard and touchpad Beeper <b>【On】</b> : press Enter switch Bee sounds Mouse Hot <b>【On】</b> : press Enter to shut down touchpad operating on OSD. Restore Values: press Enter restore the current user default value. About KVM: press Enter shows the KVM version
Edit	F6	Edits port names
QV	F7	Start or close Quick View
Lout	F8	Log out/blank the console screen
Exit	Esc	Press this key exits OSD menu
	Scroll Lock	Press this key exits OSD menu
	Num Lock	Press this key exits OSD menu

Table 4-1.2

## F1-ADM

### ● Menu overview

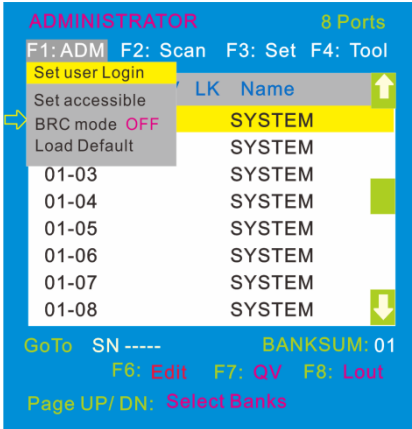

### Operating instructions

- 1) Press **[F1]** or **[←]** **[→]** enters the F1 submenus.
- 2) Press **[↑]** **[↓]** moves the highlight bar to select the submenu.
- 3) Press **[Enter]** selects and exits ADM menu.
- 4) Press **[Esc]** cancels the operation and exits ADM menu.

### ● Menu explanation

1. Set User Login—Press **[Enter]** and select Set User Login, a screen as below  
Diagram 4-1.1 appears:

One administrator and four users account can be set (*The username and password are no more than 16 characters, Press and hold the Shift key to type lowercase letters.*)

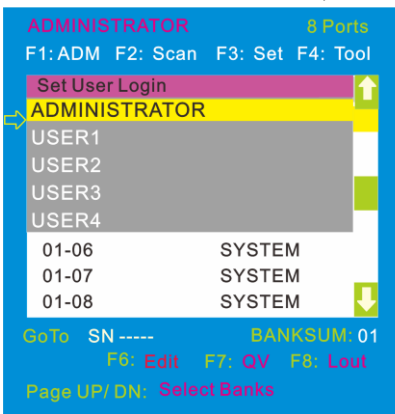

4-1.1

Enter  
→

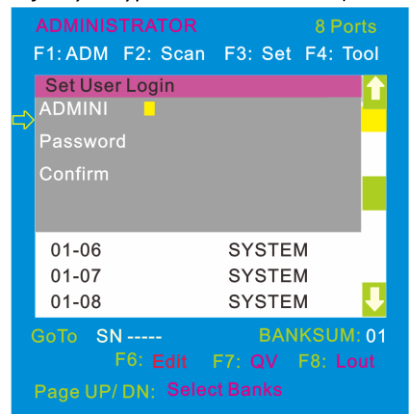

4-1.2

Note: You can set up an account and password according to diagram 4-1.2, then a “User setup ok” pops up showing you have done your set, and “Password Not Match” pops up, you need to type in your password again as you did in your first type.

2. Set accessible—press **【Enter】** and select Set Access Permission, then below menu appears: (diagram 4-1.3):

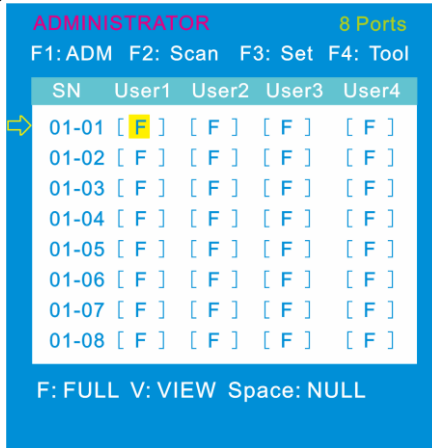

4-1.3

Menu	Explanation
FULL	Full access function to the station and can do any operation to the ports
VIEW	View only function, you can only view the port but you can't operate it if set this function.
NULL	If you set this function, the port will be not displayed on the user's OSD menu

Note: The administrator always has full access to all the ports.

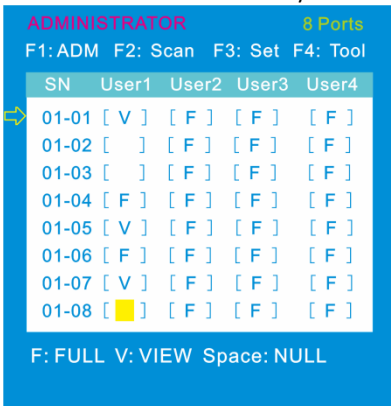

4-1.4

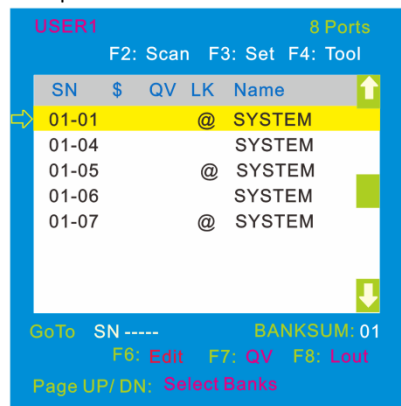

4-1.5

- Eg.:1). If you want to set access permission of [User1], press **【Space】** to choose the permission options you need to set.  
2). [User1] log in OSD menu, as shown in diagram 4-1.5.

3. BRC Mode - Press **【Enter】** to enter the BRC mode. Enter the main menu, press **【F7】** to add or remove a port that need broadcast function. When BRC mode is effect, a speaker symbol appears in QV column. (see below diagrams).

While BRC mode is in effect, we can operate multiple computer ports simultaneously, but the mouse is not function normally.

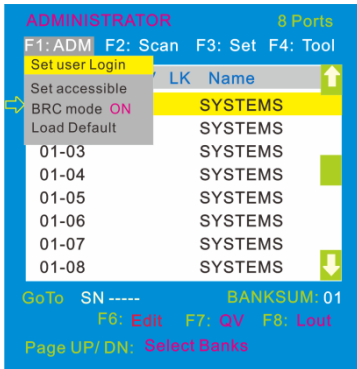

4-1.6

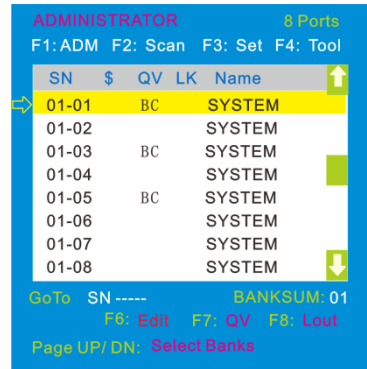

4-1.7

- 1) Open BRC mode  
**【F1】** ->BRC Mode OFF->press **【Enter】** -> BRC Mode ON (see diagram 4-1.6)
- 2) Open the port that need broadcast function  
 Press **【↑】** **【↓】** key—>select the port that need broadcast function →press **【F7】** →a “BC” symbol appears in the QV column which shows the port has entered broadcast mode.
- 3) Close the broadcasting port  
 Press **【↑】** **【↓】** key—>select the port→press **【F7】** →exit BRC mode and the “BC” symbol disappears
- 4) Exit BRC mode  
 Invoke OSD main menu → **【F1】** ->BRC Mode ON ->press **【Enter】** --> BRC Mode OFF, the KVM exits BRC mode(diagram 4-1.8)

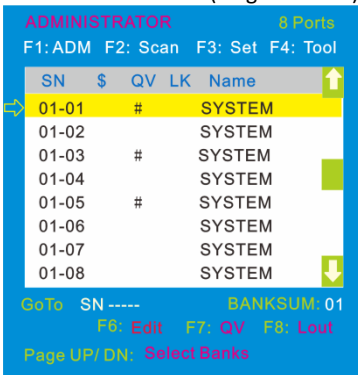

4-1.8



Press **【F1】** ->BRC Mode OFF ->press **【Enter】** ,enter the main menu, all “#” symbols turn into “BC” symbol(diagram 4-1.7 )

4. Load Default--- press **【Enter】** and select Load Default, all the set values are restored to original factory default settings.

## F2-Scan

### ● Menu overview

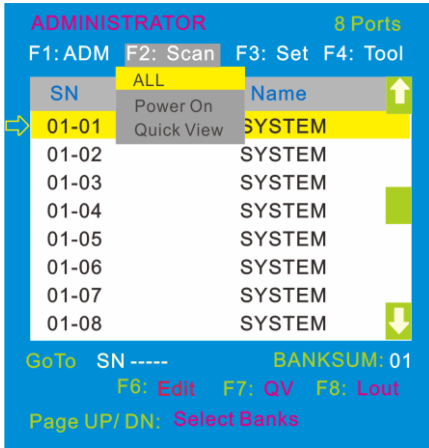

#### Operating instructions

- 1) Press **【F2】** or **【←】** **【→】** enters the F2 submenus.
- 2) Press **【↑】** **【↓】** moves the highlight bar to select the submenu.
- 3) Press **【Enter】** selects and exits Scan menu.
- 4) Press **【Esc】** cancels the operation and exits SCAN menu.

### ● Menu explanation

Submenu	Explanation
All	Use this function to scan all ports according to the set scanning interval.
Power On	Use this function to scan all ports with “\$” according to the set scanning interval.
Quick View	Use this function to scan all ports with “#” quick view symbols according to the set scanning interval.



### F3-Set

#### ● Menu overview

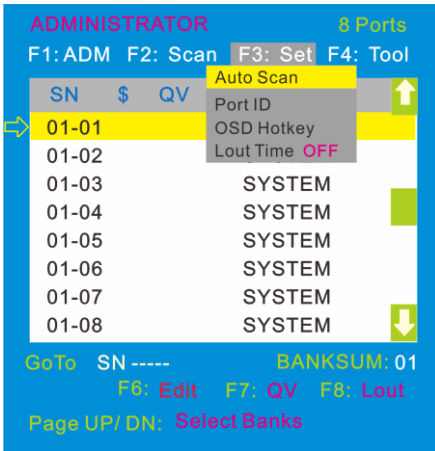

#### Operating instructions

- 1) Press **【F3】** or **【←】** **【→】** enters the F3 submenus.
- 2) Press **【↑】** **【↓】** moves the highlight bar to select the submenu.
- 3) Press **【Enter】** selects and exits Set menu.
- 4) Press **【Esc】** cancels the operation and exits Set menu.

#### ● Menu explanation

Submenu	Default value
Auto Scan	5S (effective range 5-99)
Port ID	0S: not display the port ID 1-98S: display the seconds, maximum 98s 99S: permanent display
OSD Hotkey	<b>【Scroll Lock】</b> + <b>【Scroll Lock】</b> <b>【Caps Lock】</b> + <b>【Caps Lock】</b> <b>【F12】</b> + <b>【F12】</b> <b>【Ctrl】</b> + <b>【Ctrl】</b> + <b>【KVM Hotkey】</b>
Lout Time off	0: close the screen saver setting 01-99M: set the screen saver timeout Note: It is automatically log out if the current operator is no longer operate for a while, then the KVM will be locked and you need to enter user name and password to operate again: <div data-bbox="494 1268 856 1460" data-label="Image"> </div>

## OSD Hotkey Operation

### Operating instruction

1. Press **【F3】** and move the highlight bar with **【↓】** to select “OSD Hotkey” submenu . Press **【Enter】** and below screen appears:
2. KVM default hotkey: **【Scroll Lock】**

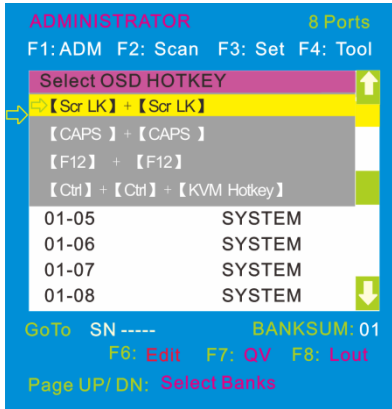

Select the “**【Ctrl】 【Ctrl】 + 【KVM Hotkey】**” and press **【Enter】**, and then the **【Ctrl】** hotkey is available in this hotkey mode, the mouse hotkey can't enter the OSD menu

Invoke hotkey: double click **【L\_Ctrl】** + the corresponding function key

Function	Operating	Function description
Switching port	+ 1~8	Skip ports from 1~8, Eg.: Double click <b>【L_Ctrl】</b> plus 2 to skip to the second port of the current station.
	+ F1~ F8	Skip ports from 9-16
	+ ↑/↓	Skip to previous/next port
Auto scanning	+ S	1. Auto Scan automatically scan ports that attached PC or server. Users can set the scan duration in OSD menu and press any key to exit scanning mode. 2. Move the mouse to extend scan interval.
Invoke OSD main menu	+ “space key”	This allows you to invoke OSD main menu ( see OSD menu operation )

**F4-Tool**

● **Menu overview**

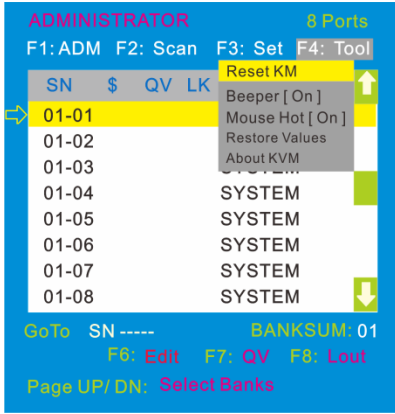

Operating instructions

- 1) Press **[F4]** or **[←]** **[→]** enters the F4 submenus.
- 2) Press **[↑]** **[↓]** moves the highlight bar to select the submenu.
- 3) Press **[Enter]** selects and exits Tool menu.
- 4) Press **[Esc]** cancels the operation and exits Tool menu.

● **Menu explanation**

Submenu	Instruction
Reset KM	Initialize the keyboard and mouse that connected to KVM when they are break down.
Beeper <b>[On]</b>	The beeper can be turned on or off with this function.
Mouse Hot <b>[On]</b>	To open and close the mouse with this function. We can't operate the OSD when it is <b>[Off]</b> .
Restore Values	Restore to original factory default values.
About KVM	It shows the KVM version information.

## F6-Edit port names

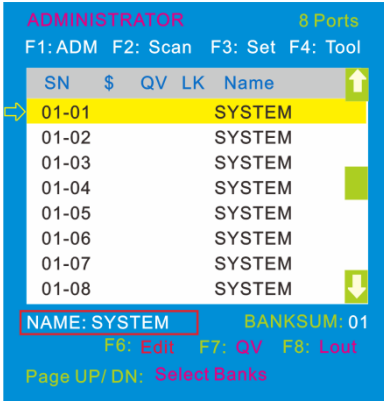

- Select the port with **【↑】** **【↓】** key;
- Press **F6** and key in the new name or modify the old one, then press **Enter** to save the name and exit editing.
- Press **【Esc】** to cancel and exit the editing.

Note:

The NAME characters include:

All alpha characters: A-Z

Press and hold the Shift key to type lower case letters

All numeric characters: 0-9

Default value: SYSTEM

## F7-Set quick view port(QV)

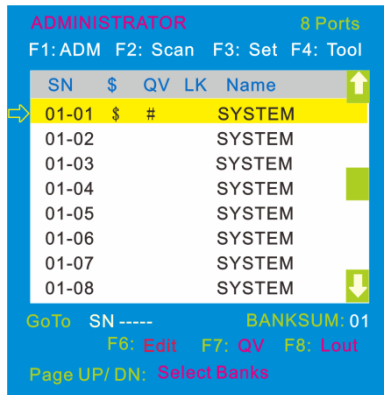

- Select ports with **【↑】** **【↓】** keys;
- Press **【F7】** to include current port as Quick View, then an arrowhead appears in the QV column to indicate so.

Note:

Press **【F7】** to cancel the QV symbol is the current port has already have a QV arrowhead symbol in its QV column; if you want to cancel all the QV function, press **Restore Values** under **F4:Tool.** (The port name restores to default setting at the same time.)

## F8-LOUT

- Press **【F8】** exits the OSD main menu and fully exits current port, then the log in window appears:

Enter Name and Password

UserName:

Password:

- Users must log in all over again to regain access to the OSD.

## Appendix

### Specifications (17.3")

Function		LD1808	LD1816
Computer connections	Direct	8	16
	Max	8	16
Port emulation	Keyboard, mouse	USB	
LED monitor	LED model	FHD TFT	
	View area	18.47"	
	Optimum resolution	1920×1080@60Hz	
	Display color	16.7 M	
	Brightness	250cd/m <sup>2</sup> ( T y p )	
	Contrast ratio	1000: 1( T y p )	
	Pixel pitch(mm)	0.213(H) × 0.213(W)	
Mouse	X/Y resolution	>1000 points /inch, (40 points/mm)	
	Roll wheel	Supports scroll wheel function	
Keyboard	99 keys (82 keys main keyboard +17 independent small numeric keyboard)		
Port selection	pushbuttons, hotkeys, OSD menu		
Input power	100V- 240Vac, 50-60Hz, <1.5A		
Power consumption	28W	30W	
Mounting distance	686-770mm ( L=262mm) Mounting bracket can be customized for other mounting distance		
Operating temperature	0—50 °C		
Store temperature	-20—60 °C		
Humidity	0—80% RH, non-condensing		
Net weight	11.8kg	12kg	
Product dimension (W × D × H)	448mm×560mm×42.5mm		
Package dimension (W × D × H)	765mm×615mm×185mm		

## FAQ

1. The KVM console do not work when I connect and use the console for the first time.

Solutions:

Please re-connect the KVM console according to below steps:

- 1) Disconnect all the signal and power cables connected to KVM.
- 2) Then power on KVM and you hear the boot indicating sound from the beeper, a screen automatically pop up for you to enter the user name and password.
- 3) Type in the correct user name and password, the original password is clicking Enter twice, then the OSD main menu pop up on the screen.
- 4) Check the KVM console and make sure it can normally switch ports .
- 5) Connect one server(PC) to one of the KVM ports with signal cable and check port switching function, check the keyboard and mouse, if they are not working, try to re-start the server(PC).
- 6) After successfully finishing all above steps, gradually add server(PC) to this console until meet your need.

2. I can't log in the KVM system after starting computer.

Solutions:

- 1) Make sure the KVM keyboard is working, the user name and password is correct. The default value is blank, you can log in after press Enter.
- 2) If you still can't log in the system, try to connect an external USB keyboard.( The original default value is blank, you can log in after double clicking Enter )

3. I can't switch from one port to another after logging in the KVM system.

Solutions:

- 1) Invoke the OSD main menu and check the user name on the top left, make sure the user has got the access permission from the administrator.
- 2) Please contact the distributor or the KVM manufacturer.

4. Bad display quality of PC screen.

Solutions:

- 1) Check the signal cables, make sure they are connected.
- 2) Reset the monitor's display settings.

5. When I switch to one port, the keyboard and mouse do not work.

Solutions:

- 1) Make sure you have exited the OSD menu.
- 2) Invoke the OSD main menu and check the user name on the top left, make sure the user has got the access permission from the administrator.
- 3) Pull out the USB port of the server(PC) then plug in.

6. I can't invoke the OSD main menu.

Solutions:

- 1) Check the keyboard to make sure it is working.
- 2) Double click **【Scroll\_Lock】** .
- 3) Double click **【F12】**
- 4) Double click **【Caps Lock】**
- 5) Double click **【Ctrl】 + 【Space】**