

Rackmount KVM Console

(8 Port / 16 Port / 24 Port / 32 Port)

User Manual



www.kinankvm.com

@all right reserved Shenzhen Kinan Technology Co., Ltd

Print date: 2024/10

Version: V5.5

Contents

- Overview..... 3**
 - Description 3
 - Features..... 3
 - Structure and Size (17")..... 5
 - Structure and Size (19")..... 5
 - Rear View 6
- Hardware Installation..... 7**
 - Rack Mounting 7
 - Installation Diagram 8
 - KVM Adapter 9
- Operation..... 10**
 - LED Operating Instructions..... 12
- OSD Operation 14**
 - OSD Functions 15
 - F1-ADM 16
 - F2-Scan..... 19
 - F3-Set 20
 - F4-Tool..... 22
 - F6-Edit port names..... 23
 - F7-Set Quick View port 23
 - F8-LOUT 23
- Appendix..... 24**
 - Specifications(17") 24
 - Specifications (19") 25

Overview

Description

The KVM console integrates multiple-port CAT5 KVM switches in a 1U height console. Multiple computers can be controlled from the single monitor-keyboard-mouse console.

It is easy and fast to install the CAT5 KVM console; you just need to connect corresponding cables to the right ports of the CAT5 KVM and its module without software configuration.

KVM console can connect multiple computers with RJ-45 connector and CAT5 connecting cables. Transmission distance is up to 100M, so it doesn't need a KVM extender.

Features

- 17" & 19" LCD TFT monitor, high brightness, high resolution
- Metal 19" rack with 1U height
- Ultra slim 99 keys keyboard (PS/2) with small numeric keyboard
- High resolution and high flexibility with touchpad; with two function buttons and scroll wheel, standard PS/2 port

Switch Functions

- Access and control up to 8 / 16 / 24 / 32 computes
- Support servers with VGA/ HDMI/ DVI/DP port
- Supports Multiple systems: Windows, Linux, Mac and Sun
- Two level password security--only authorized users view and control computers; up to four users and an administrator with a separate profile for each
- Convenient computer switching via front panel pushbuttons, hotkeys, OSD menu or mouse
- Auto scan feature for monitoring user-selected computers
- Broadcast mode--operations simultaneously performed on all selected computers
- Keyboard and mouse emulation function.
- USB or PS/2 keyboard emulation--computer boot even the console focus is else where
- Hot pluggable --add or remove computers without having to power down the switch

Front View

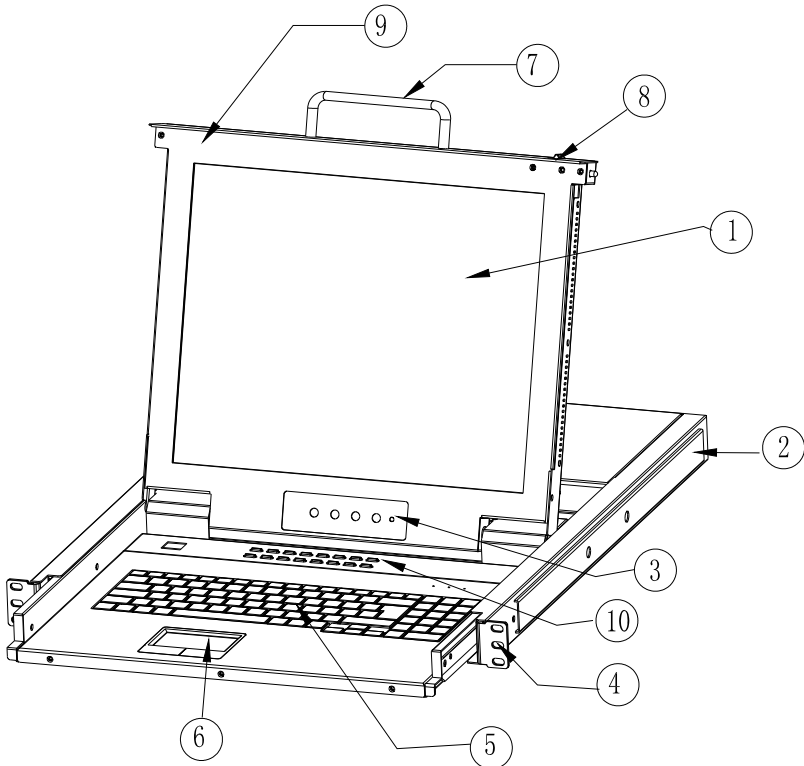

1-1.1 front view

- 1. LCD Module
- 2. Rear Bracket Slot
- 3. OSD Controls
- 4. Front bracket
- 5. Keyboard
- 6. Touchpad
- 7. Handle
- 8. Release Catch
- 9. Display Panel
- 10. Switch LED

Structure and Size (17")

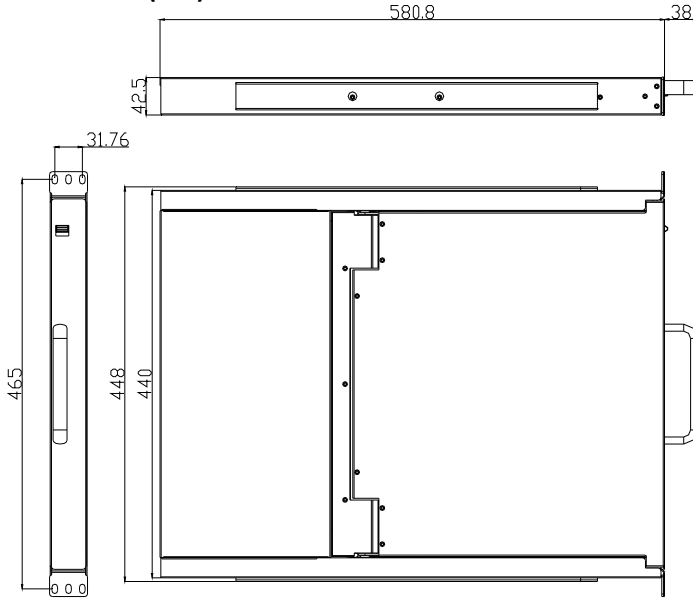

1-1.2

Structure and Size (19")

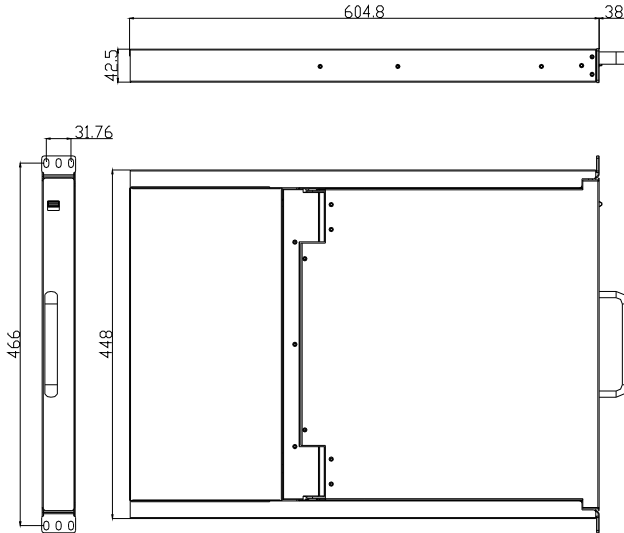

1-1.3

Rear View

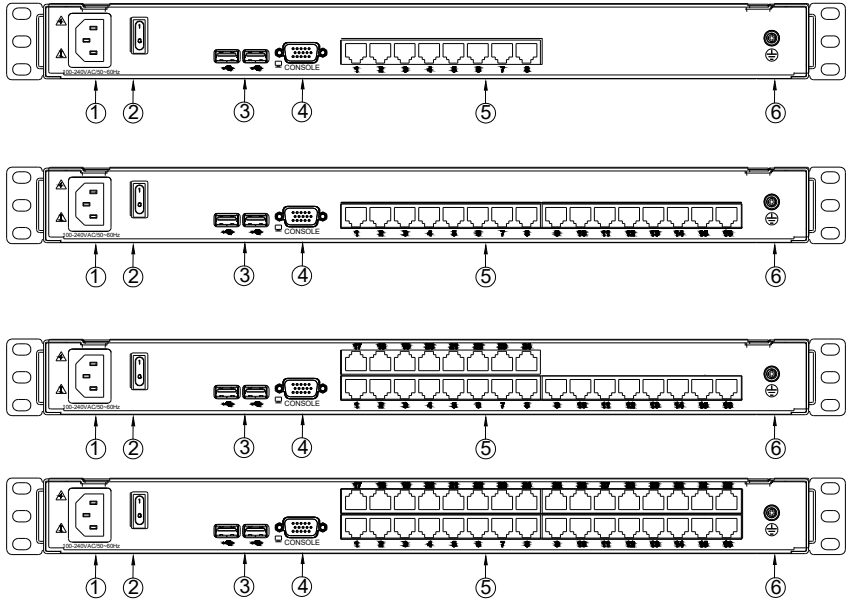

1-1.4

No.	Explanation
1	Power input (AC or DC)
2	Power Switch
3	USB Port
4	Monitor Port
5	PC connecting port
6	Ground connecting screw

Hardware Installation

Rack Mounting

A standard rack mounting kit is provided to mount the switch in a depth of 600-850mm (17"), 716-825mm (19") in a standard 19" rack.

For other mounting distance, the rear brackets need to be customized accordingly With one person hold the switch in place and the other person slides the L bracket into the switch's side mounting brackets from the front to the back, then screws the brackets to the rack.(see below installation drawing)

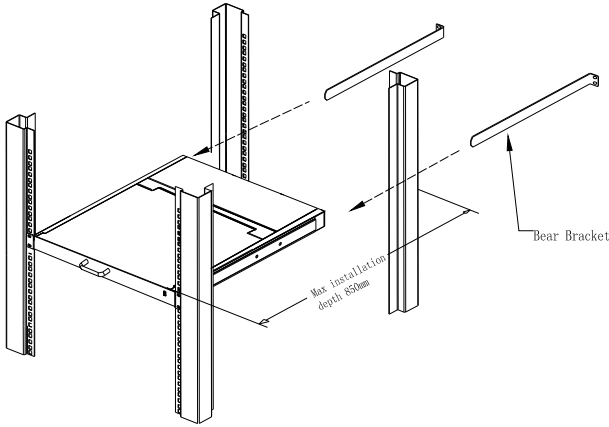

2-1.1 rack mounting (1)

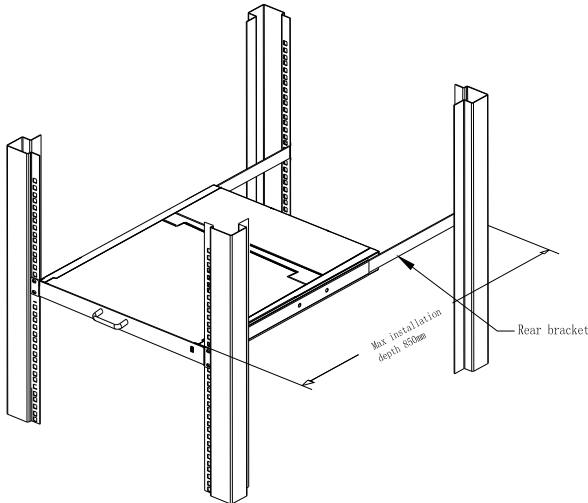

2-1.2 rack mounting (2)

Installation Diagram

- 1) Make sure the KVM console has been connected to the ground.(①)
- 2) Connect any available KVM port and KVM adapter with CAT5 cables.(②)
- 3) Connect the adapter to the KVM and the PC or server(③)
- 4) Plug the female port of the power cable in the KVM power socket, and plug the male port in the AC power port.(④)

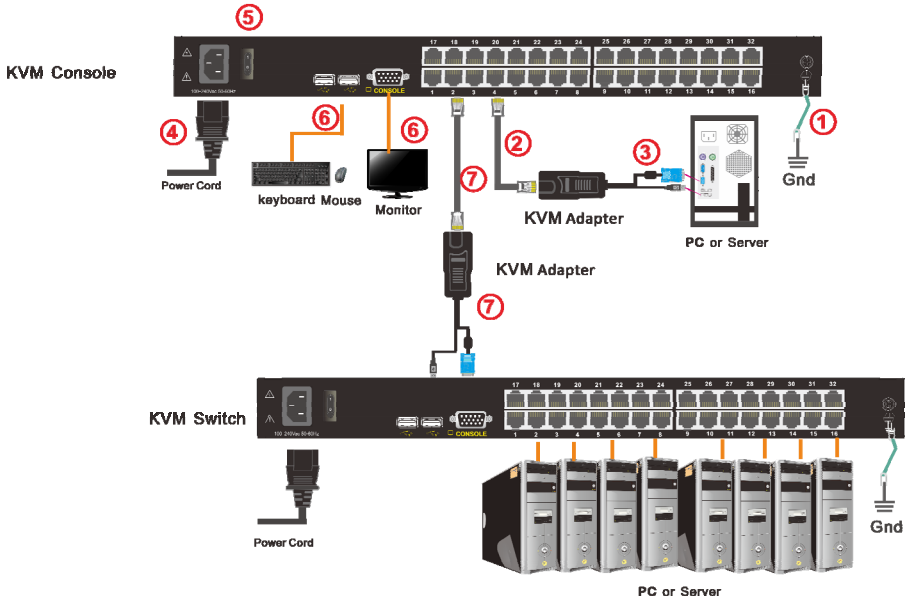

2-1.3 Install KVM components

Note:

1. Connect external USB keyboard, mouse and monitor according to the(⑥)step in
2. If cascading required, please connect KVM console and KVM switch with adapter (⑦), and Hotkey need to be different with KVM console and KVM switch.

Please check the hotkey setting

2.1 Turn off Mouse Hotkey function (F4: Tool ->Mouse Hot **【On】**)

2.1 Keyboard hotkey setting (F3: Set -> OSD Hotkey)

【Caps Lock】 + **【Caps Lock】**

【F12】 + **【F12】**

【Ctrl】 + **【Ctrl】** + **【KVM Hotkey】**

KVM Adapter

PS/2 Adapter

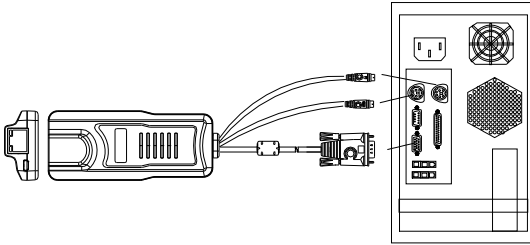

Model No.	Keyboard/Mouse	PC	Explanation
KCM-1100P	PS/2	VGA	Connect to PS2 / VGA server

USB Adapter

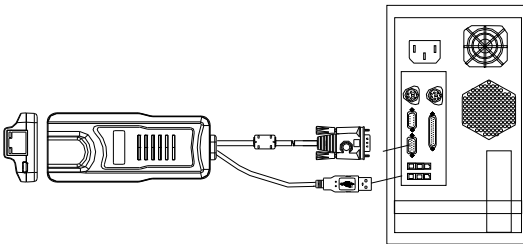

Model No.	Keyboard/Mouse	PC	Explanation
CM-1200U	USB	VGA	Connect to USB/VGA server
KCM-3200H	USB	HDMI	Connect to USB/HDMI server
KCM-2200D	USB	DVI	Connect to USB/DVI server
KCM-4200P	USB	DP	Connect to USB/DP server

Table1 : LED Indicator of the KVM Adapter

Components	Function	
Green	Online	Indicates that the corresponding host has been connected to the KVM switch and Power On.
Orange	Selected	Indicates that the corresponding host is in use.

Operation

- Release the release catch;

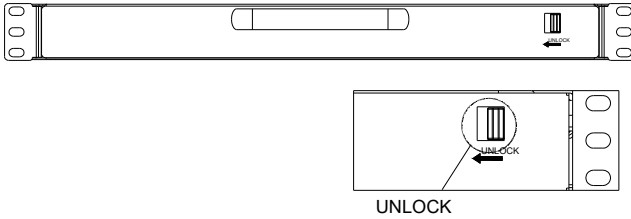

2-2.1 unlocking

***Note: The release lock can only do horizontal locking, it can't bear any load.**

- Pull the KVM console all the way out until it clicks into place;
- Rotate the LCD module all the way back to expose the LCD screen; the LCD module can be rotated up to 108°.

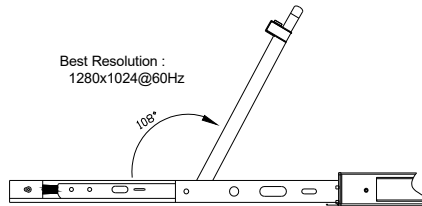

2-2.2 open angle of the console

- The KVM makes two “beep” sounds after power on, an OSD window appears for you to input user name and password.

8 Port /16 Port: The orange LED and LED tube are flashing before you enter your password.

24 Port /32 Port:  appears on LED tube without user name and password.

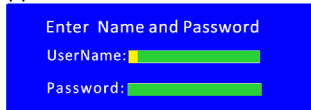

2-2.3 password window

- LED panel is powered on when the power LED is green.
- Power on the computer or server after power on the KVM.
 8 Port /16 Port: The LED of the connected port is green.
 24 Port /32 Port: There is no port LED.

The factory default pass word is blank; double click “Enter” to log in.

NOTE: The username and password are no more than 16 characters, Press and hold the Shift key to type lowercase letters.

Please contact the manufacturer for support if the KVM is locked.

Closing the console

- Close the LCD display panel and the power automatically shut down.
- Push the release catch in the direction of the arrow; pull the LED panel all the way in until it automatically locks up.

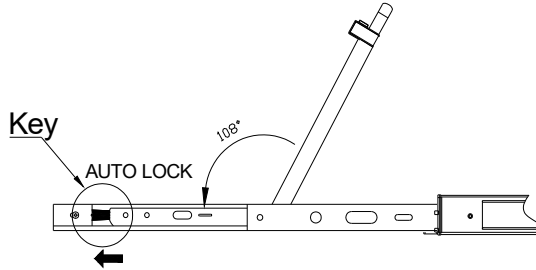

2-2.4 unlocking the console

LED OSD Configuration



The LED OSD allows you to set up and configure the LED display.

Buttons	Functions
MENU SELECT	Press this button invokes the menu function and brings up the main menu.
EXIT/AUTO	Press this button exits the current menu and returns to the previous menu or presses this button exits the LED OSD. Press AUTO for automatic configuration.
SL-/SL+	Press this button moves your menu to make corresponding adjustment.
LED state	Green :running Red: power off or access non standard VESA signal Flash green: energy saving mode or no signal





Press AUTO if the screen migrates after power on or under other circumstances, then the screen auto configure to its best display state.(It might can't be adjusted to its best state if part of the display mode is not standard VESA mode, if so return back to OSD menu to RESET, then it will back to normal.

We suggest our customers to set up the display mode at 1280x1024, refresh rate at

LED Operating Instructions







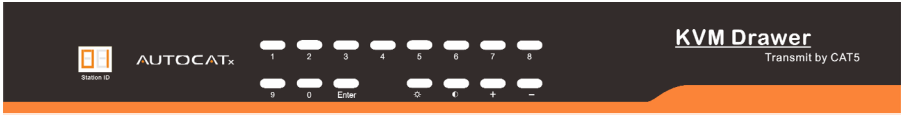



3-1.1 16 Port LED button front view

No.	Components	Function
1	1-16	Switching freely from port 1 to port 16
	Reset	Press 【1】 and 【2】 at the same time for three seconds resets the keyboard and mouse
	Scan	Press 【7】 and 【8】 at the same time for three seconds enters the auto scan mode.
	Brightness 	Press 【3】 for three seconds enters brightness adjusting mode. 33 are flashing on the LED tube. Then press 【5】 , 【6】 to adjust. Press 【3】 exits or waits for five seconds and it will auto-exit.
	Definition 	Press 【4】 for three seconds enters definition adjusting mode. 44 are flashing on the LED tube. Then press 【5】 , 【6】 to adjust. Press 【4】 exits or waits for five seconds and it will auto-exit
Initialize  	Press 【6】 for three seconds will initialize the brightness and definition of each port.	
2	Port Selection Buttons & LEDs	Indicator LEDs are built into the switches, the online LED light is on the left and the selected LED light is on the right. 1. An online LED light (green) indicates that the KVM has connected to its corresponding computer and power on. 2. A selected LED light (orange) indicates that the computer attached to its corresponding port is up and running.
3	Station ID	Display the current port



3-1.2 24Port /32 Port LED button front view

No.	Components	Function
1	0~9 +Enter	Switching from port 1 to port 32 Port 8 : If you want to switch to Port 8, press【8】, and the LED light displays  , then press “Enter”, you will come to Port 8. Port 32: If you want to switch to Port 32, press 【3】 and 【2】, the LED light displays  , and then press “Enter”, you will come to Port 32.
2	 (+, -)	Adjust Brightness Press  , the LED light blinking with  , and then press “+” and “-”to adjust the brightness.
3	 (+, -)	Adjust Definition Press  , the LED light blinking with  , and then press “+” and “-”to adjust the definition.
4	Station ID	Display the current port

OSD Operation

Double click the right button of the mouse or double click hotkey **【Scroll Lock】** to invoke below OSD main menu. You can customize the OSD hotkeys; find more details in OSD function instructions.

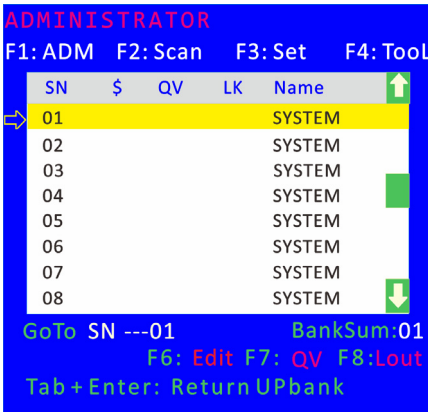

Headings	Explanation
SN	port number
⇒	It shows the computer port is under monitoring.
\$	The computers are power on and are online
QV	"#": quick view the port "BC": Broadcast port
LK	"@" shows that the port is only available for viewing
Name	Port name, the maximum is 12 bytes

To access the OSD menu through keyboard:

1. In the submenus that appears, moving the highlight bar to your selected port and then press Enter.
2. Press any key from **【0-9】** to enter any port of current station

To access the OSD menu through mouse:

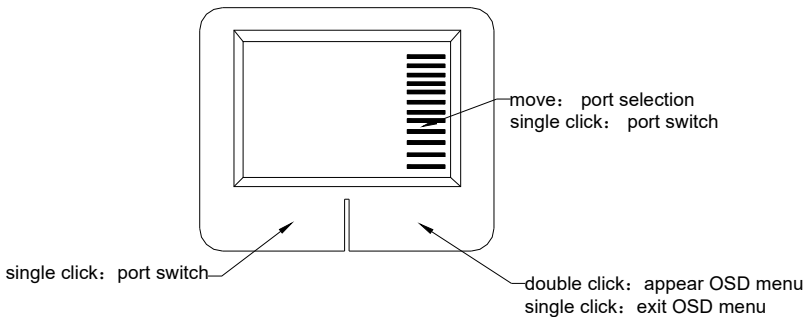

*Note: Operate via keyboard after invoke the OSD menu via the touchpad.

OSD Functions

Menu	Keys	Submenu/Explanation
ADM	F1	Set User login-Set User login account and password Set accessible-Set access permissions BRC Mode -monitor multiple computers at the same time Load Default-reset the menu to the original factory default settings
Scan	F2	All-Lists all the ports on the installation Power On-lists only powered on ports that have attached computers. Quick View-Lists only the ports that have been selected as Quick View ports
Set	F3	Auto Scan-set scanning time period Port ID-set how long a port displays on the monitor OSD Hotkey-set OSD hotkeys Lout Time off- to set the time out value
Tool	F4	Reset RGB-Press Enter reset RGB Beeper 【On】 -press Enter switch Bee sounds Mouse Hot 【On】 -press Enter to close touchpad operating on OSD. Restore Values-press Enter restore the current user default value. About KVM- press Enter shows the KVM version
Edit	F6	Edits port names
QV	F7	Start or close Quick View
Lout	F8	Log out/lock the KVM
Exit	Esc	Press this key exits OSD menu
	Scroll Lock	Press this key exits OSD menu
	Num Lock	Press this key exits OSD menu

Table 4

The display screen will be distorted if the CAT5 cable is too long, for this case, you can adjust according to below steps:

1. Press **【+】** and ADJ FOCUS will pop up, then press **【+】** , **【-】** to adjust definition.
2. Press **【,】** and ADJ BRIGHT will pop up, then press **【,】** , **【.】** to adjust brightness.



F1-ADM

● Menu Overview

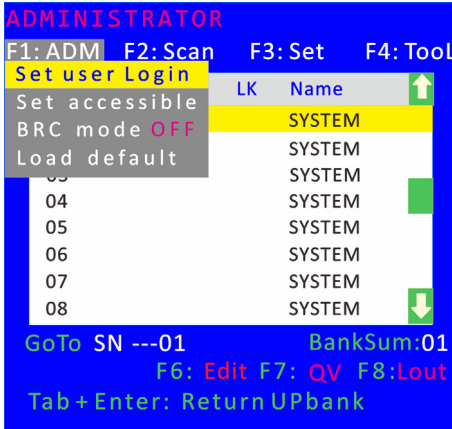

Operating instructions

- 1) Press **[F1]** or **[←]** **[→]** enters the F1 submenus.
- 2) Press **[↑]** **[↓]** moves the highlight bar to select the submenu.
- 3) Press **[Enter]** selects and exits ADM menu.
- 4) Press **[Esc]** cancels the operation and exits ADM menu.

● Menu Explanation

1. Set User Login—Press **[Enter]** selects Set User Login and a screen as below diagram 4-1.1 appears:

One administrator and four users account can be set (*The username and password are no more than 16 characters, Press and hold the Shift key to type lowercase letters.*)

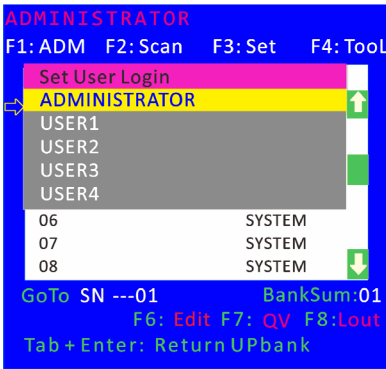

Diagram 4-1.1

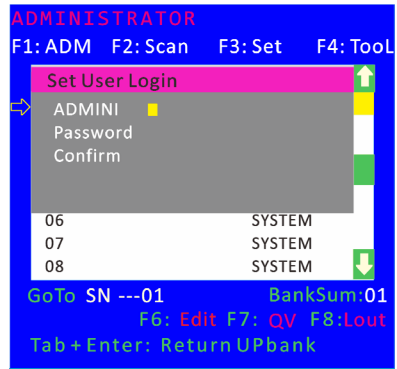

Diagram 4-1.2

Note: You can set up an account and password according to diagram 4-1.2, then “User setup ok” pops up showing that you have done your set,” and if “Password Not Match” pops up, you need to type in your password again as you did in your first type.

2. Set Accessible—press **[Enter]** to select Set Accessible, then below menu appears: (diagram 4-1.3)

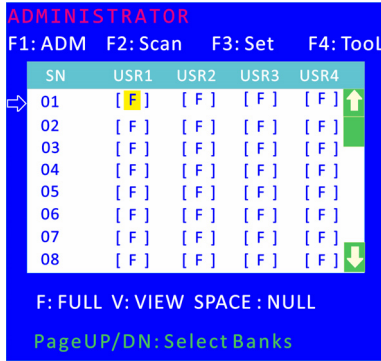

Diagram 4-1.3

Menu	Explanation
FULL	Full access function to the station and can do any operation to the ports
VIEW	Read only function, you can only read the port but you can't operate it if set this function.
NULL	If you set this function, the port will be not displayed on the user's OSD menu

Note: The administrator always has full access to all the ports.

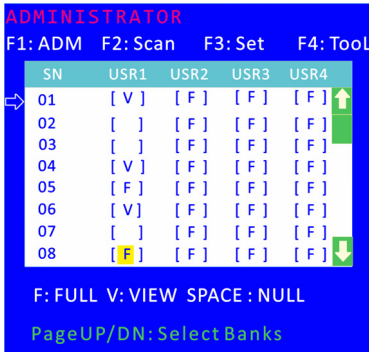

Diagram 4-1.4

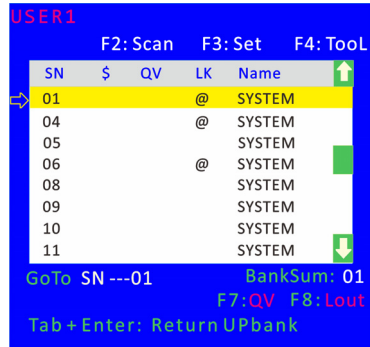

Diagram 4-1.5

- E.g.: 1) If you want to set access permission of [User1], press **[Space]** to select the permission options you need to set.
2) [User1] log in OSD menu, below diagram 4-1.5.

3. BRC Mode Off - Press **[Enter]** to enter the BRC mode, enter the main menu, press

【F7】 to add or delete a port that need broadcast function. When BRC mode is effect, a speaker symbol appears in QV column. (See below diagrams). While BRC mode is in effect, we can synchronous operate multiple computer ports. Note: While BRC mode is in effect, the mouse is forbidden to use.

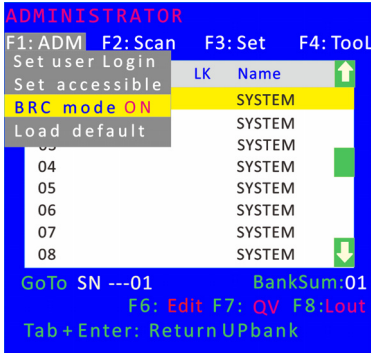

Diagram 4-1.6

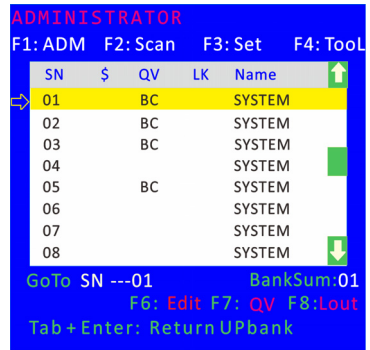

Diagram 4-1.7

1)Open BRC mode

【F1】 ->BRC Mode OFF-> [Enter] -->BRC Mode ON (diagram 4-1.6)

2) Open the port that need broadcast function

Press **【↑】** **【↓】** key—>select the port that need broadcast function → **【F7】** → a “BC” symbol appears in the QV column which shows the port has entered broadcast mode.

3) Close the broadcasting port

Press **【↑】** **【↓】** key—>select the port→press **【F7】**→exit BRC mode and the “BC” symbol disappears

4) Exit BRC mode

Invoke OSD main menu → **【F1】** ->BRC Mode ON -> [Enter] --> BRC Mode OFF, KVM exit BRC mode (diagram 4-1.8)

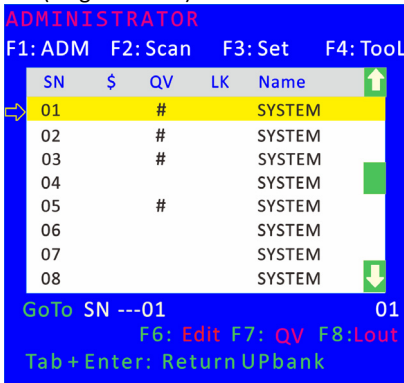

Diagram 4-1.8

Press **【F1】** ->BRC Mode OFF ->press **【Enter】** ,enter the main menu, all “#” symbols turn into “BC” symbol (diagram 4-1.7)

4. Load Default-- press [Enter] to select the submenu, all the set values are restoring to original factory default settings.

F2-Scan

● **Menu Overview**

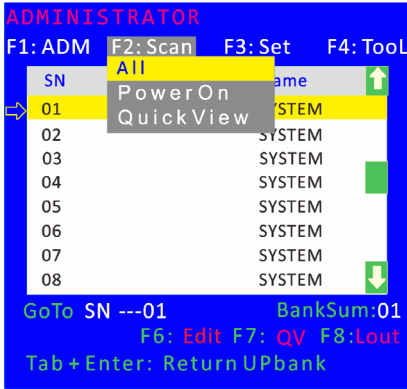

Operating instruction

- 1) Press **【F2】** or **【←】** **【→】** enters the F2: submenus.
- 2) Press **【↑】** **【↓】** moves the highlight bar to select the submenu.
- 3) Press **【Enter】** selects and exits Scan menu.
- 4) Press **【Esc】** cancels the operation and exits SCAN menu.

● **Menu Explanation**

Submenu	Explanation
All	Use this function to scan all ports according to the set scanning interval.
Power On	Use this function to scan all ports with“\$”according to the set scanning interval.
Quick View	Use this function to scan all ports with “#” quick view symbols according to the set scanning interval.

F3-Set

● **Menu Overview**

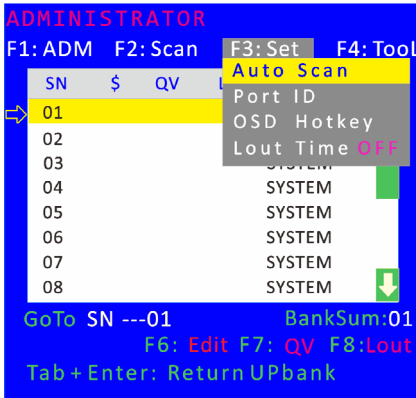

Operating instructions

- 1) Press **【F3】** or **【←】** **【→】** enters the F3 submenus.
- 2) Press **【↑】** **【↓】** moves the highlight bar to select the submenu.
- 3) Press **【Enter】** selects and exits Set menu.
- 4) Press **【Esc】** cancels the operation and exits Set menu.

● **Menu Explanation**

Submenu	Default value
Auto Scan	5S (effective range 5-99)
Port ID	0S: not display the port ID 1-98S: display the seconds, maximum 98s 99S: permanent display
OSD Hotkey	【Scroll Lock】 + 【Scroll Lock】 【Caps Lock】 + 【Caps Lock】 【F12】 + 【F12】 【Ctrl】 + 【Ctrl】 + 【KVM Hotkey】
Lout Time off	0: off 01-99M:set the screen saver timeout, it is automatically log out if the current operator is no longer operate for a while, then the KVM will be locked and you need to enter user name and password to operate again <div data-bbox="553 1220 861 1332" style="border: 1px solid black; background-color: #000080; color: white; padding: 5px; margin: 10px auto; width: fit-content;"> <p style="text-align: center;">Enter Name and Password</p> <p>UserName: <input style="background-color: #00FF00; border: none;" type="text"/></p> <p>Password: <input style="background-color: #00FF00; border: none;" type="password"/></p> </div>

OSD Hotkey Operation

Operating instruction

1. Press **【F3】** and move the highlight bar with **【↓】** to select “OSD Hotkey” submenu.
Press **【Enter】** and below screen appears:
2. KVM default hotkey: **【Scroll Lock】**

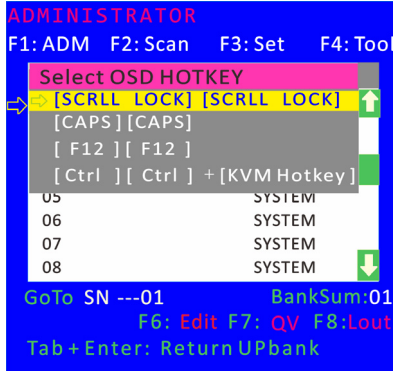

2. Select the “ **【Ctrl】 【Ctrl】 + 【KVM Hotkey】** ” and press **【Enter】** , and then the **【Ctrl】** hotkey is available in this hotkey mode, the mouse hotkey can't enter the OSD menu

Invoke hotkey: double click **【L_Ctrl】** + the corresponding function key

Function	Operating	Function description
Switching port	+2 number keys	Eg.: switch to port 4 by hotkeys 【L_Ctrl】 + 【L_Ctrl】 + 【0】 + 【4】
	+ F1~ F8	Skip ports from 1-8
Invoke OSD main menu	+ “space ”	This allows you to invoke OSD main menu (see OSD menu operation)

F4-Tool

● **Menu Overview**

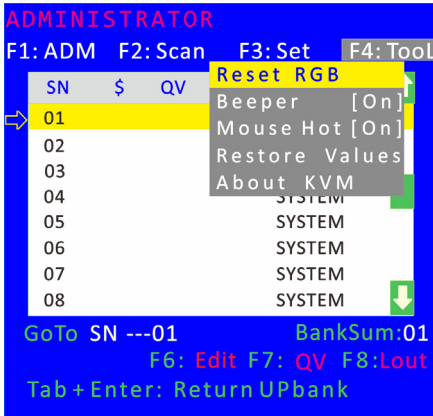

Operating instructions

- 1) Press **【F4】** or **【←】** **【→】** enters the F4 submenus.
- 2) Press **【↑】** **【↓】** moves the highlight bar to select the submenu.
- 3) Press **【Enter】** selects and exits Tool menu.
- 4) Press **【Esc】** cancels the operation and exits Tool menu.

● **Menu Explanation**

Submenu	Instruction
Reset RGB	Restore the video signal to the default value.
Beeper 【On】	The beeper can be turned on or off with this function.
Mouse Hot 【On】	To open and close the mouse with this function. We can't operate the OSD when it is 【Off】 .
Restore Values	Restore to original factory default values.
About KVM	It shows the KVM version information.

F6-Edit port names

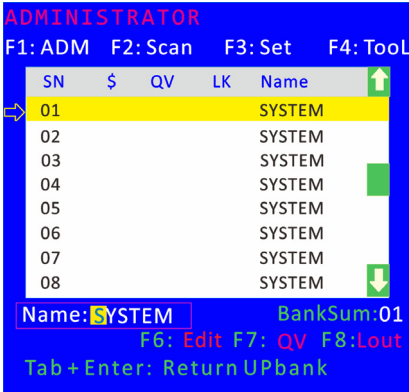

- Select the port with **【↑】** **【↓】** key;
- Press F6 and key in the new name or modify the old one, then press Enter to save the name and exit editing.
- Press **【Esc】** to cancel and exit the editing.

Note:

The NAME characters include:

All alpha characters: A-Z

Press and hold the Shift key to type lowercase letters

All numeric characters: 0-9

Default value: SYSTEM

F7-Set Quick View port

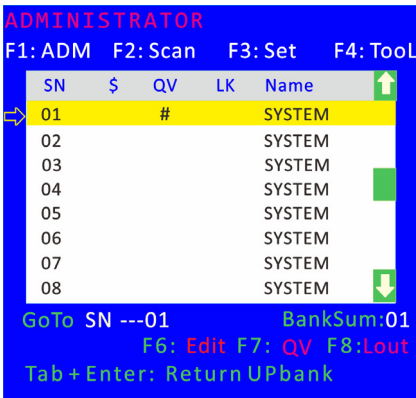

- Select ports with **【↑】** **【↓】** keys;
- Press **【F7】** to include current port as Quick View, then an arrowhead appears in the QV column to indicate so.

Note:

Press **【F7】** to cancel the QV symbol is the current port has already have a QV arrowhead symbol in its QV column; if you want to cancel all the QV function, press Restore Values under F4:Tool.(The port name restores to default setting at the same time.)

F8-LOUT

- Press **【F8】** exits the OSD main menu and fully exits current port, then the log in window appears:

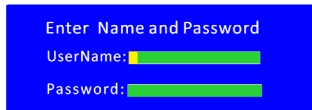

- Users must log in all over again to regain access to the OSD.

Appendix**Specifications(17")**

Model		LC1708	LC1716	LC1724	LC1732
Computer connections	Direct	8	16	24	32
	Max	256	512	768	1024
Port emulation	Keyboard, mouse	PS/2, USB			
LCD monitor	LED model	SXGA TFT			
	View area	17 "			
	Optimum resolution	1280×1024@60Hz			
	Display color	16.7 M			
	Brightness	250cd/m ² (Typ)			
	Contrast ratio	1000 : 1 (Typ)			
Mouse	Pixel pitch(mm)	0.264(H) × 0.264(W)			
	X/Y resolution	>1000 points / inch, (40 points/mm)			
Keyboard	Roll wheel	Supports scroll wheel function			
		99 keys (82 keys main keyboard +17 independent small number pad)			
Port selection	pushbuttons, hotkeys, OSD menu				
Input power	100V- 240Vac, 50-60Hz, <1.5A				
Power consumption	19W	20W	21W	22W	
Mounting distance	600~850mm (L=420mm) Mounting rails can be customized for other mounting distance.				
Operating temperature	0 — 50 °C				
Store temperature	-20 —60 °C				
Humidity	0—80% RH, non-condensing				
Net weight	12.8kg	12.8 kg	13kg	13kg	
Product dimension (W × D × H)	448mm×581mm×42.5mm				
Package dimension (W × D × H)	765mm×615mm×185mm				
Optional power input	-36V~ -72V DC				

Specifications (19")

Model		LC1908	LC1916	LC1924	LC1932
Computer connections	Direct	8	16	24	32
	Max	256	512	768	1024
Port emulation	Keyboard, mouse	PS/2, USB			
LCD monitor	LED model	SXGA TFT			
	View area	19"			
	Optimum resolution	1280×1024@60Hz			
	Display color	16.7 M			
	Brightness	250cd/m ² (Typ)			
	Contrast ratio	1000 : 1 (Typ)			
	Pixel pitch(mm)	0.2928(H) × 0.2928(W)			
Mouse	X/Y resolution	>1000 points / inch, (40 points/mm)			
	Touchpad with trackball	Eliminates the need for an external mouse			
Keyboard	99 keys (82 keys main keyboard +17 independent small number pad)				
Port selection	pushbuttons, hotkeys , OSD menu				
Input power	100V- 240Vac , 50-60Hz , <1.5A				
Power consumption	20W	21W	22W	23W	
Mounting distance	716~825mm (L=262mm) Mounting rails can be customized for other mounting distance.				
Operating temperature	0 — 50 °C				
Store temperature	-20 —60 °C				
Humidity	0—80% RH, non-condensing				
Net weight	13.4kg	13.4kg	13.6kg	13.6kg	
Product dimension (W × D × H)	448mm×605mm×42.5mm				
Package dimension (W × D × H)	765mm*615mm*185mm				
Optional power input	-36V~ -72V DC				