

IP KVM Matrix Extender

User Manual

www.kinankvm.com

@all right reserved Shenzhen Kinan Technology Co., Ltd

Print date: 2024 /11

Version: V1.0

User Information

Telephone Support

For telephone support, please call below number:

TEL	0086-755-26755041
MOBILE	0086-13714411566

User Notification

All information, documentation, and specifications contained in this manual are subject to change without prior notice. The manufacturer does not make any explicit or implied statement or guarantee about the contents of this document, especially for merchantability or fitness for any specific purpose. Any manufacturer's equipment described in this manual is sold or licensed as it is.

If the equipment is damaged artificially after purchase, the buyer (not the manufacturer, its distributor or reseller) shall bear all costs for necessary repair and any losses caused by equipment defects.

If the correct operating voltage setting is not selected before operation, the manufacturer will not be responsible for any damage caused by system operation.

Please make sure the voltage has been set correctly before use.

- User Information** 1
 - Telephone Support 1
- 1. Introduction** 3
 - 1.1 Function 4
 - 1.2 Feature 4
 - 1.3 Safety Instructions 4
 - 1.4 Product Overview 6
 - KFH188S receiver (TX)..... 6
 - KFH188S sender (RX) 7
- 2. Installation** 8
 - 2.1 Installation of Extender..... 8
- 3. Extender Configuration** 10
 - 3.1 Use of UI Interface 10
 - [Name Setting of TX_List]..... 11
 - [Auto Scan Setting]..... 12
 - [User Login Interface] 13
 - [The list of matched TX/RX] 13
 - 3.2 Function Setting 14
 - [Equipment Info] 15
 - [Equipment Setting]..... 16
 - [Frame Push] 18
 - [Frame Get] 18
 - [Update] 20
 - [Hotkeys] 21
- 4. Specifications** 22
 - Specifications of KFH188S 22

1. Introduction

The KFH188S IP KVM matrix extenders are highly optimized KVM extenders. The point-to-point connection supports transmission distance of 120m, and resolution up to 3840x2160@30Hz. This series of extenders can be connected to an 1G network switch to form a matrix switching system, which supports point-to-point (P2P) mode and matrix (Matrix) mode. The matrix switching system composed of extenders supports up to 9999 nodes by using a centralized management software, and it can support up to 40 nodes without using a centralized management software. It can connect multiple signal sources (such as servers, workstations, cameras and video walls).

With the matrix switching system, computers and servers can be located in the central server room far from the workstation to improve security, reduce the temperature and noise of the working environment, and achieve a quiet and friendly human-computer interaction environment.

The video compression algorithm of KFH188S matrix extender is a perfect combination of high-quality image and low latency (<8ms). The USB and video signals are transmitted through CAT5e/6/7 network cable.

It supports USB devices such as touch screen, USB sound card, printer, etc., it can also support USB storage devices.

1.1 Function

This product is intended to be used as a device to increase the distance that a keyboard, monitor and mouse can be placed from a computer. This product is intended for professional use. The product should not be used in potentially explosive environments.

The product may only be used according to the instructions as described in this manual. All use, other than that described in this manual, is seen as unintended use. In this product, the product connected to the host end is called the transmitter (TX), and the product connected to the display end is called the receiver (RX).

1.2 Feature

- HDMI / USB2.0/Audio/Rs232 - IP KVM Matrix Extender
- Supports dual-link backup connections (dual optical/dual network /1 optical and 1 network)
- Supports local (TX) HDMI port loop-out
- Single screen version
- Point-to-point connection supports maximum extension distance 120m/394ft
- Support seamless switching
- Freeze the last image after the disconnection of transmitter and receiver
- Support resolution up to 3840x2160@30Hz (4:4:4)
- USB transmission rate up to 480Mbit/s
- HDMI lossless real-time full HD transmission
- Support transmission through fiber optic and network (CAT5e/6/7)
- Support one Administrator account and one User account

1.3 Safety Instructions

WARNING! Read and understand all safety instructions.

- Please follow all instructions. This will avoid accidents, fire, explosions, electric shocks or other hazards that may result in damage to property and/or severe or fatal injuries. Please ensure that everyone who uses the product has read and followed these warnings
- Keep all safety information and instructions for future reference and pass them on to subsequent users of the product.
- The manufacturer is not liable for cases of material damage or personal injury caused by incorrect handling or non-compliance with the safety instructions. In

such cases, the warranty will be voided.

- The product is not allowed to use in potentially explosive environments.
- Check the product and the cables for any damage before use. If there is any visible damage, a strong odour, or excessive overheating of components unplug all the connections immediately and stop using the product.
- If the product is not installed and used in accordance with this manual, it may cause disruptive interference with radio or television reception or affect other electronic products in residential areas.
- Use shielded cables to connect components to avoid the above interference.
- Only the power adapter included with the product should be used as the power supply. Do not use other adapters.
- Make sure your local voltage matches the rating indicated on the product before powering on it.
- The product must be connected to a permanent and earthed AC wall socket.
- Protect cables from being strained, pinched or buckled and place them in a way to prevent people from tripping over the cord.
- Avoid any damage to power adapter.
- Use the product with a suitable, properly installed and easily accessible power socket to make sure the product can be disconnected from the power socket at all times.
- Disconnect the product when not in use.
- Never touch the adapter with wet hands.
- Use the product within the specified performance limits.
- Keep the product away from any flammable materials like curtains.
- Protect the power adapter from use by third parties (particularly children).
- Keep the product away from heater.
- Do not drop or hit the product.

1.4 Product Overview



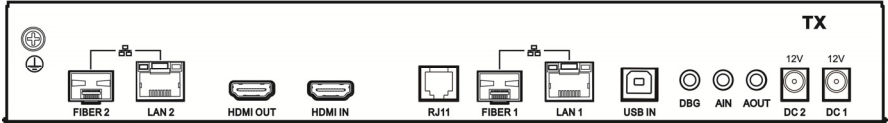

KFH188S receiver (TX)

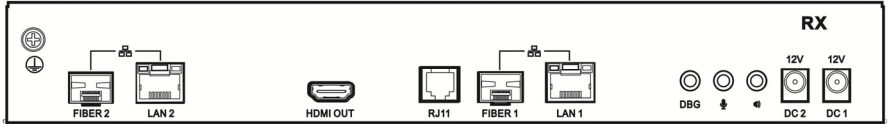

No.	Components		Description
1	LED	PWR1, PWR2	Power indicator
		LINK1, LINK2	Connection indicator
		FIBER1, FIBER2	Connection indicator of FIBER
		SLED	System indicator
2			Ground the device
3	FIBER2, FIBER1		Fiber interface
4	LAN2, LAN1		LAN interface
5	HDMI OUT		HDMI video output
6	HDMI IN		HDMI video input
7	RJ11		Serial Port
8	USB IN		USB-B, connect to PC or server
9	DBG		Debug interface
10	AIN		Audio input
11	AOUT		MIC output
12	DC2, DC1		Connect to the 12V power supply

KFH188S sender (RX)



No.	Components		Description
1	LED	PWR1, PWR2	Power indicator
		LINK1, LINK2	Connection indicator
		FIBER1, FIBER2	Connection indicator of FIBER
		SLED	System indicator
2	SW		button
3			Connect to a USB keyboard
4			Connect to a USB mouse
5	USB2.0		Connect to USB2.0 peripherals
6			Ground the device
7	FIBER2, FIBER1		Fiber interface
8	LAN2, LAN1		LAN interface
9	HDMI OUT		HDMI video output
10	RJ11		Serial Port
11	DBG		Debug interface
12			MIC input
13			Audio output
14	DC2, DC1		Connect to the 12V power supply

2. Installation

2.1 Installation of Extender

Warning! Please read and be aware of all safety instructions before installing the equipment. The extender can be set as a point-and-point mode to access a single PC, and also can access multiple PCs through matrix switching system.

Matrix switching system

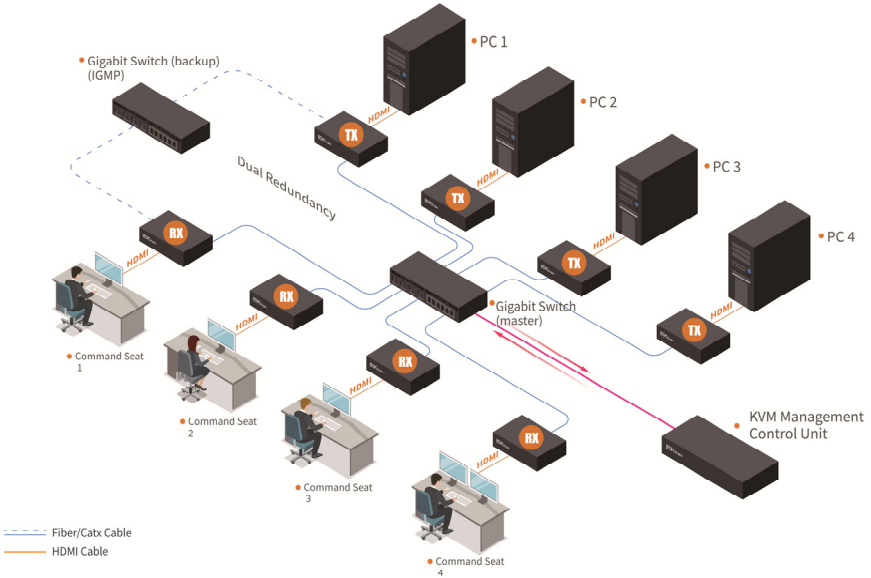

Configuration requirements: The electrical port of the network switch must reach a gigabit rate and support IGMP multicast.

Connection Diagram of KFH188S

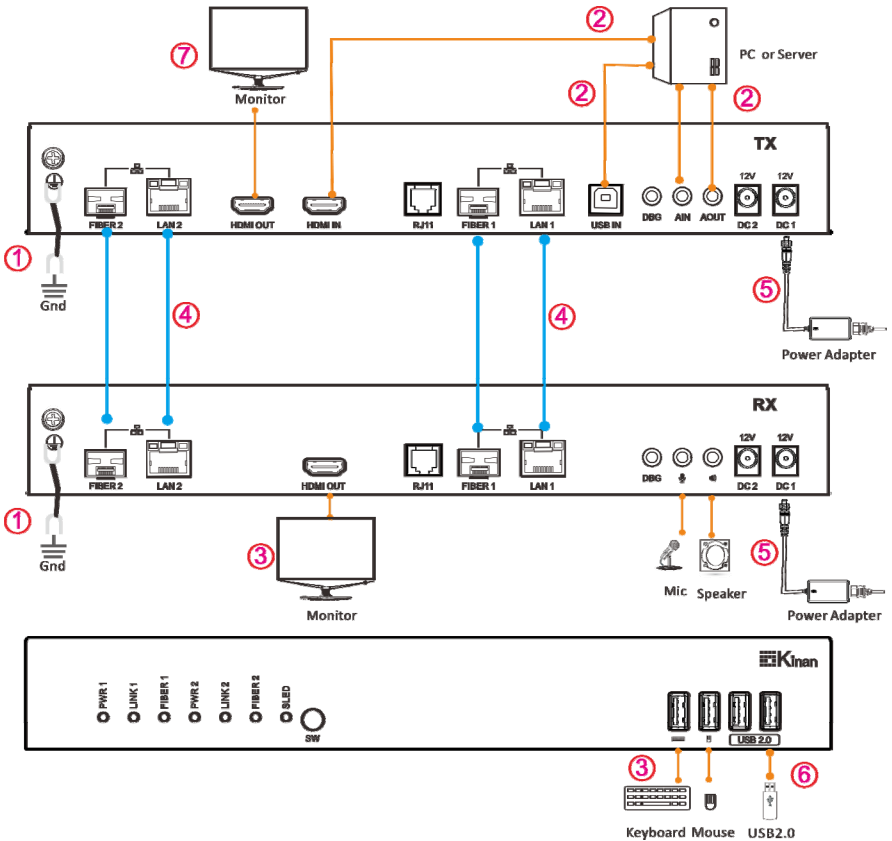





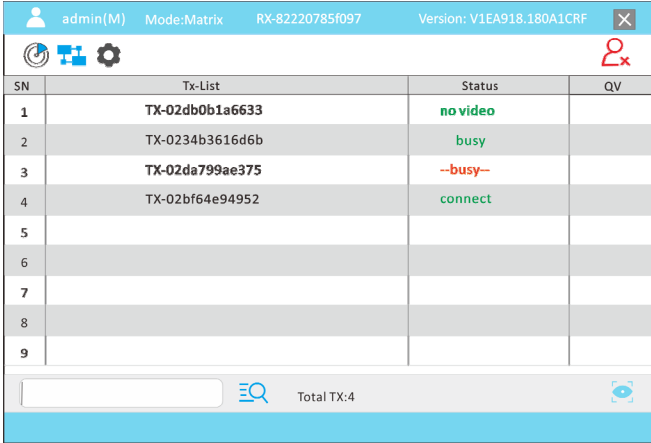

1. Make sure the KVM extender is grounded (See ① in the above diagram)
2. Connect the KFH188S_TX to the HDMI video port, USB port and audio port of a computer. (See ② in the above diagram)
3. Connect the KFH188S_RX to keyboard, mouse, monitor and audio device. (See ③ in the above diagram)
4. Connect the transmitter and receiver interfaces via optical fiber or CAT5E cable. (See ④ in the above diagram)
5. Power on the transmitter and receiver. (See ⑤ in the above diagram)
6. Connect the USB peripheral to the receiver (KFH188S_RX) (See ⑥ in the above diagram)

3. Extender Configuration

3.1 Use of UI Interface

Press the left [Ctrl] key on the keyboard 3 times continuously, then the main UI interface will display.



Function Name	Description
admin(M)	M: Main Link S: Backup Link
Mode	Matrix mode P2P mode Node mode
	Scan device list
	The list of matched transmitter and receiver
	Setting of function key
	Click 【Equipment setting】 - 【User Setting Pass】 to logout user account
SN	Number of connected devices
TX_List	List of transmitters
Status	Busy: TX and RX are paired --Busy-- : The RX has been connected to a TX No video: There is no video input from the host Connect: Can be connected
QV	Select Scan device
	Find the devices in the list
	Auto Scan

[Name Setting of TX_List]

Double-click the name of a TX, and then the following name setting window appears.

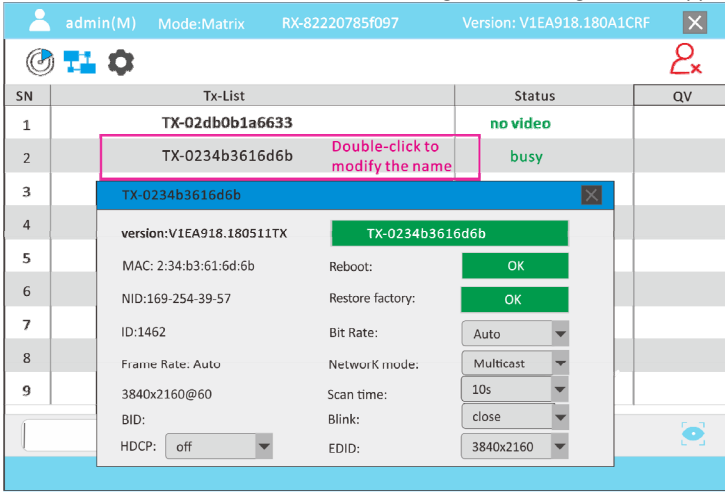





Function Name	Description
TX-0234b3616d6b	Click to change the name of TX, and then click “ESC” button to confirm your modification.
Reboot	Reboot the device
Restore factory	Restore Factory Defaults
Bit Rate	Auto, 10M ,50M, 100M, 150M, 200M
Network mode	Multicast mode Unicast mode
Scan time	10s, 20s, 30s, 60s, 90s ,120s, 150s, 180s, 210s, 255s
Blink	To set PWR flashing time, check TX connection status. You can choose from “Close, 1 min, 10 min, 30 min, 60 min, always”.
HDCP	Turn on/off internal test mode RX and TX must be set to the same
EDID	AUTO, 1024x768, 1280x1024, 1366x768, 1600x900 , 1920x1080, 1920x1200, 2560x1440, 3840x2160, 1152x864, 2048x2048,1600x1200,1920x1920, 2160x2160, 2560 x1600, 3840 x1080, 4096 x1080, 2560 x2880



[Auto Scan Setting]

Select TX devices, click the QV item, and then click “

admin(M) Mode:Matrix RX-82220785F097 Version: V1EA918.180A1CRF



   

SN	Tx-List	Status	QV
1	TX-02db0b1a6633	no video	Scan
2	TX-0234b3616d6b	busy	Scan
3	TX-02da799ae375	--busy--	Scan
4	TX-02bf64e94952	connect	Scan
5			
6			
7			
8			
9			

 Total TX:4 

Scan time: 10s, 20s, 30s, 60s, 90s, 120s, 150s, 180s, 210s, 255s

[User Login Interface]

The default setting mode is “password mode: ” (See User Setting on Page 18), the login interface will only appear after clicking the icon .



User Name:

Password:

User Name:	admin
Password:	admin

[The list of matched TX/RX]

Click function key [], and then the following menu appears:

admin(M) Mode:Matrix RX-82220785f097 Version: V1EA918.180A1CRF	
TX	RX
TX-02db0b1a6633	RX-826d9539bf91
TX-0234b3616d6b	
TX-02da799ae375	RX-82220785f097
TX-02bf64e94952	RX-82bcf4d41966

When you see the device name in the TX list and the RX list, that means that the TX and RX are matched successfully.

3.2 Function Setting



Click the function key [], and then below menu appears:

 admin(M)
Mode:Matrix
RX-82220785f097
Version: V1EA918.180A1CRF
✕

Operating mode: Matrix

system state: ✔ Usb ✔ Audio ✔ KM ✔ Share

Output timing: 1080p@60

Total TX: 4 Total RX:2

MAC: 82:22:7:85:f0:97

MID: 169-254-39-57

BID: 000000000000-0

Version: V1EA918.180A1CRF

Equipment info

Equipment setting

Frame push

Frame Get

Update

Hotkeys

Function Name	Description
Equipment Info	To switch on/off USB, Audio, KM, Get & Push
Equipment Setting	System and User Settings
Frame Push	Push the video and USB signals from current receiver to the chosen receiver in the list
Frame Get	Get the video and USB signals from any receiver in the list to the current receiver
Upgrade	Update device
Hotkey	Hotkeys of device

[Equipment Info]

Select to switch on/off the system state.

admin(M) Mode:Matrix RX-82220785f097 Version: V1EA918.180A1CRF

Operating mode: Matrix

system state: Usb Audio KM Share

Output timing: 1080p@60

Total TX: 4 Total RX:2

MAC: 82:22:7:85:f0:97

MID: 169-254-39-57

BID: 000000000000-0

Version: V1EA918.180A1CRF

Equipment info

Equipment setting

Frame push

Frame Get

Update

Hotkeys

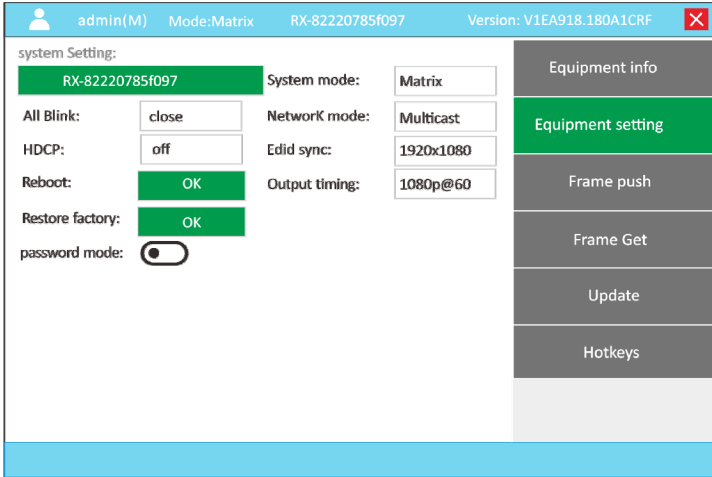

Function Name	Description
Usb2.0	USB2.0 function
Audio	Audio function
KM	Keyboard and Mouse
Share	Push video & Get video

[Equipment Setting]





Function Name	Description
RX-82220785f097	Click to change the name of RX, and then click "ESC" button to confirm your modification.
All Blink	To set PWR flashing time You can choose from "Close, 1 min, 10 min, 30 min, 60 min, always".
HDCP	Turn on/off internal test mode RX and TX must be set to the same
Reboot	Reboot device
Restore factory	Restore factory defaults
System mode	Matrix mode P2P mode Node mode
Network mode	Multicast mode Unicast mode
Edid Sync	AUTO, 1024x768, 1280x1024, 1366x768, 1600x900 , 1920x1080, 1920x1200, 2560x1440, 3840x2160, 1152x864, 2048x2048,1600x1200,1920x1920, 2160x2160, 2560 x1600, 3840 x1080, 4096 x1080, 2560 x2880
Output timing	1080P@60, 2160P@60, 640 x 480P@60, 800x600P@60 1024 x 768P@60,1280 x1024P@60, 1366x768, 1440x900 , 1920x1200, STRICT PASS, AUTO PASS
Password mode	Modify user name and set permissions

User Setting:

Click “”, swipe right to “”, and then the following menu appears. You can modify user password and set permissions.

You can't set the user name and password in Node mode, they can be set on the management control unit.

 admin(M) Mode:Matrix RX-82220785f097 Version: V1EA918.180A1CRF 

system Setting:

RX-82220785f097

All Blink:

HDCP:

Reboot:

Restore factory:

password mode:

Name	Password	Permissions		
admin	admin	<input checked="" type="checkbox"/> Usb	<input checked="" type="checkbox"/> Audio	<input checked="" type="checkbox"/> KM
		<input checked="" type="checkbox"/> share		
user	user	<input checked="" type="checkbox"/> Usb	<input checked="" type="checkbox"/> Audio	<input checked="" type="checkbox"/> KM
		<input type="checkbox"/> Share		

Equipment info

Equipment setting

Frame push



Frame Get

Update

Hotkeys



Function Name	Description
Password	Double click the name in the password list to modify the password of corresponding user.
Permissions	Set permissions for USB2.0, Audio, KM, Frame Get, and Frame Push.

[Frame Push]

admin(M) Mode:Matrix RX-82220785f097 Version: V1EA918.180A1CRF				✖
SN	Rx-List		Push	
1	 RX-826d9539bf91		Push	Equipment info
2	 RX-824970a75774		Push	Equipment setting
3	 RX-82bcf4d41966		Push	Frame push
4				
5				Frame Get
6				
7				Update
8				
9				Hotkeys
10				
11				
12				

Click [Push] to push the video and USB signals from current receiver to the chosen receiver in the list.

[Frame Get]

admin(M) Mode:Matrix RX-82220785f097 Version: V1EA918.180A1CRF				✖
SN	Rx-List		Get	
1	 RX-826d9539bf91		Get	Equipment info
2	 RX-824970a75774		Get	Equipment setting
3	 RX-82bcf4d41966		Get	Frame push
4				
5				Frame Get
6				
7				Update
8				
9				Hotkeys
10				
11				
12				

Click [Get] to get the video and USB signals from any receiver in the list to the current

receiver.

Connection Diagram of Collaborative Sharing Push & Get

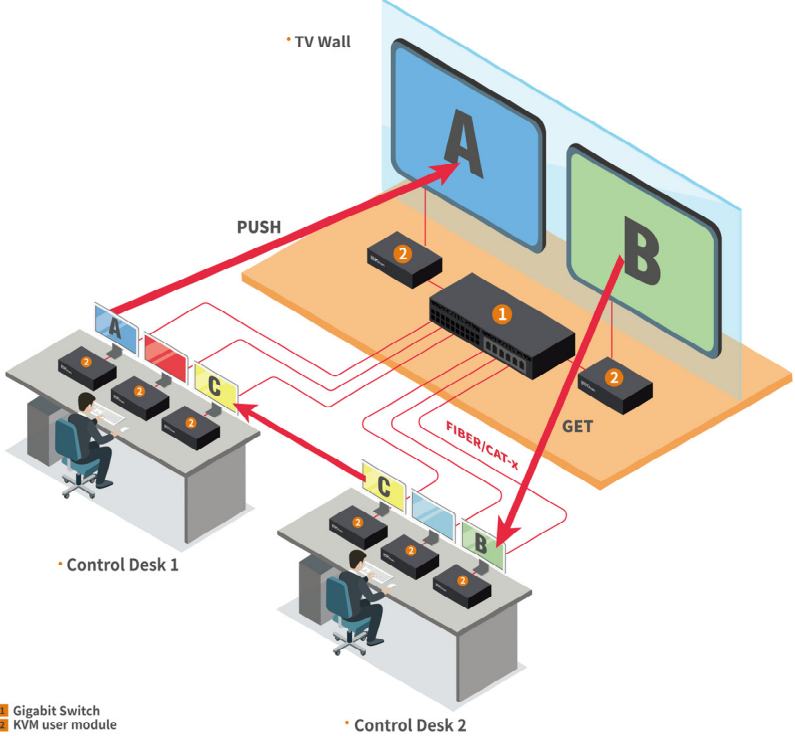

[Update]

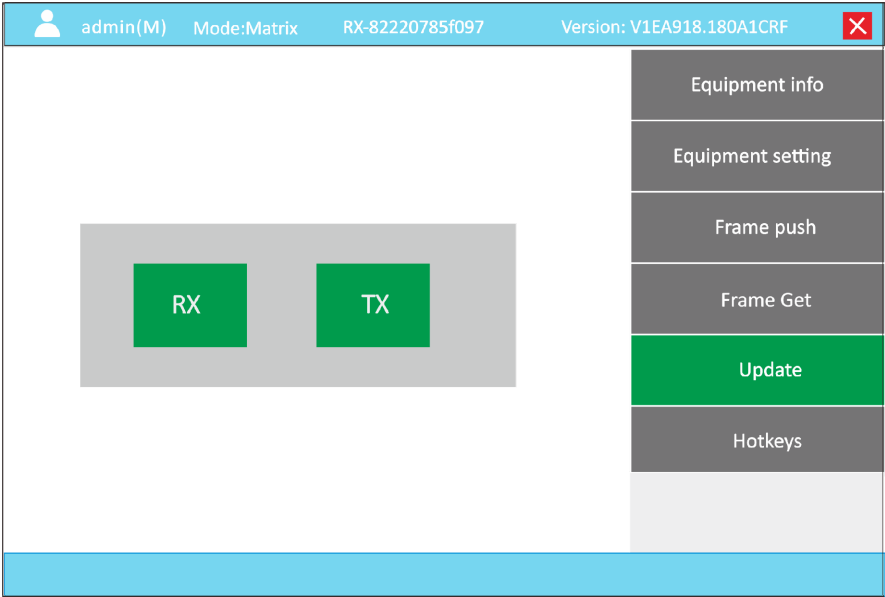

Click **【RX】** to update RX

Click **【TX】** to update TX

[Hotkeys]

admin(M) Mode:Matrix RX-82220785f097 Version: V1EA918.180A1CRF

Press the hotkey 3 time quickly

- left Ctrl ----> Shows or Hides the UI
- left Shift ----> Disconnect host
- right Ctrl ----> Next or previous channels

Switch hotkey

- hold down right Ctrl+ double -click1-0 --> Switch from channel 1 to10

Equipment info

Equipment setting

Frame push

Frame Get

Update

Hotkeys

Function Name	Description
Left_Ctrl	Shows or Hides the UI
Left_Shift	Disconnect host
Right_Ctrl	Next or previous channels
Right_Ctrl+Doulbe 【1-0】	Switch from channel 1 to 10

4. Specifications

Specifications of KFH188S

Specifications		KFH188S_TX	KFH188S_RX
Connections	HDMI input	1	N/A
	HDMI output	1	1
	Power	12V x 2	12V x 2
	LAN port	RJ45 x 2	RJ45 x 2
	Optical Module	SFP+ x 2	SFP+ x 2
	Mic	3.5MM Stereo Jack (Green)	3.5MM Stereo Jack (Pink)
	Speaker	3.5MM Stereo Jack (Pink)	3.5MM Stereo Jack (Green)
	Square USB	1	N/A
	USB	1	4
Resolution		3840x2160@60Hz	
Cable		CAT5e/6/7 or Optical Fiber Cable	
I/R Value		DC12V / 3A	DC12V / 3A
Power consumption		15W	15W
Operating temperature		0—50 ℃	
Storage temperature		-20—60 ℃	
Humidity		0—80% RH, non-condensing	
Material		Metal	
Net weight(kg)		1.78 kg	1.8kg
Product dimension (W × D × H)		317mm x 216.1 mm x 44mm	
Package dimension (W × D × H)		395mm x 274mm x110 mm	395mmx274mmx110 mm