

Rack Mount 17"&19"Console User Manual



www.szkinan.com

@all right reserved Shenzhen Kinan Technology Co.,Ltd

Printing Date: 2014/08

Version: V2.0

Description

Single port console integrate the monitor, keyboard and mouse in a 1U height device, it can be installed in a standard 19" rack. It can connect one computer to control the monitor, keyboard and mouse.

Features

- 3 in 1 LED console integrating the monitor, keyboard and mouse.
- Directly connect computer or KVM switch to control single or multiple computers.
- 17" & 19" LED monitor with high brightness, high definition and high resolution.
- Ultra-slim keyboard with 99 keys (82+17) .
- Standard PS/2 touchpad.
- With release catch in front panel.
- Automatic-locking guide rail

Appearance

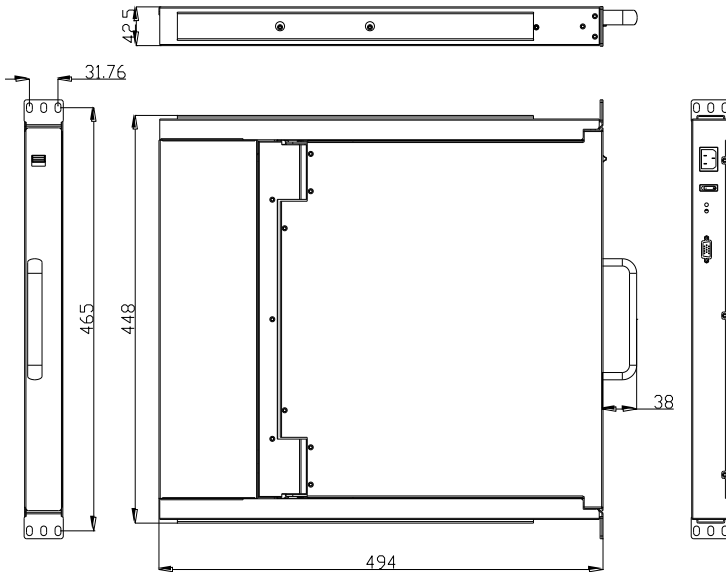

1.1 appearance

Cable Connection

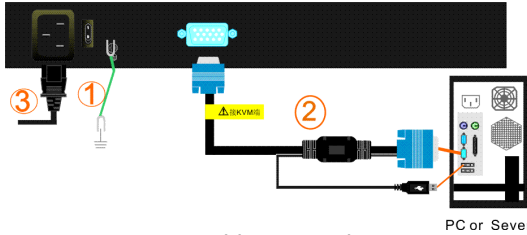

1.2 cable connection

No.	Function	Model	Cable port
①	KVM signal cable – PS/2	CH-1800P(1.8M) CH-3000P(3M) CH-5000P(5M)	PC or Server port: Keyboard: 6pin MIN-DIN male Mouse: 6pin MIN-DIN male Monitor: 15pin HDB male
			KVM port: 15pin HDB male
①	KVM signal cable – USB	CH-1800U(1.8M) CH-3000U(3M) CH-5000U(5M)	PC or Server port: USB: USB A TYPE(female) Monitor: 15pin HDB male
			KVM port: 15pin HDB male
②	AC power cable	CAC3-1800(1.8M)	Wide voltage range: 100~240VAC / 50~60Hz

Table 1-1.1 cables

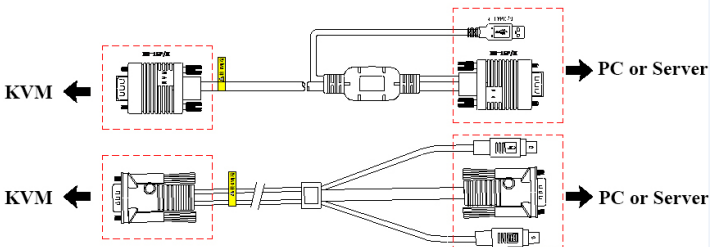

To ensure signal integrity and simplify cable layout, we strongly recommend you use high quality cables with different length as shown in above table.

Front View

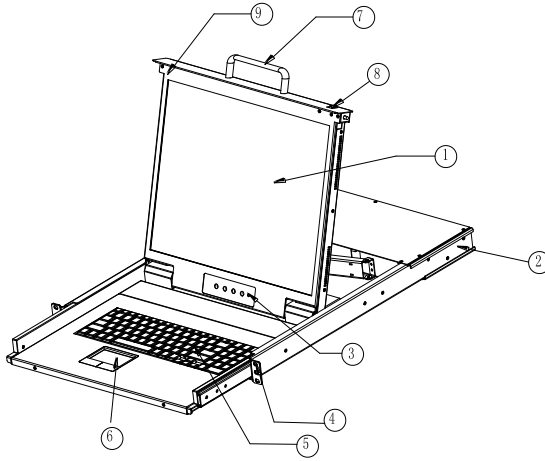

1-1.3 front view

- 1. LED Monitor
- 2. Rear Bracket Slot
- 3. OSD Controls
- 4. Front Bracket
- 5. Keyboard
- 6. Touchpad
- 7. Handle
- 8. Release Lock
- 9. Display Panel

Back View

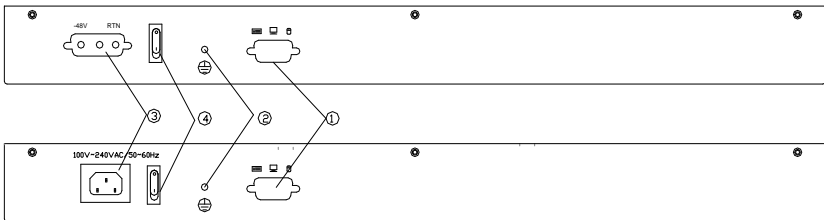

1-1.4 back view

- 1 PC connection port: integrating VGA,keyboard and mouse signal
- 2 Ground connecting screw
- 3 Power input(AC or DC)
- 4 Power Switch

Rack Mounting

A standard rack mounting kit is provided to mount the switch in a depth of 600-850mm in a standard 19" rack.

With one person hold the switch in place and the other person slides the L bracket into the switch's side mounting brackets from the front to the back, then screws the brackets to the rack. (See below installation diagrams)

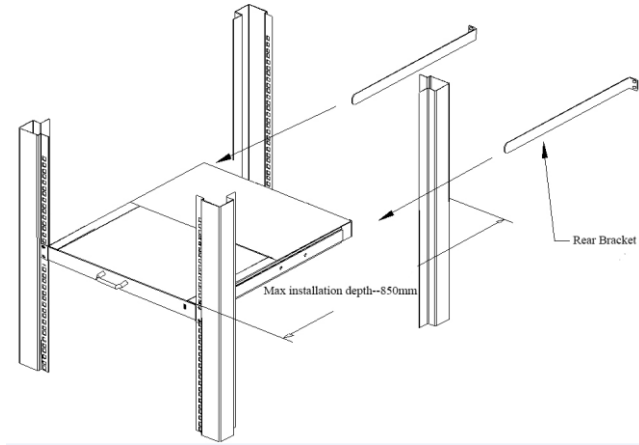

1-2.1 rack mounting (1)

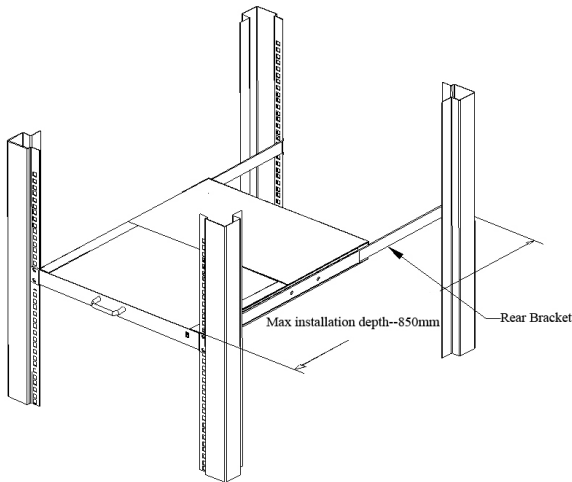

1-2.2 rack mounting (2)

Opening the Console

- Power on the KVM after connecting cables.
- Power on the server or PC after power on the KVM.
- Release the release catch.

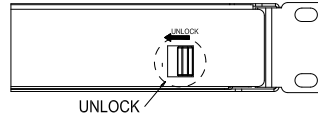
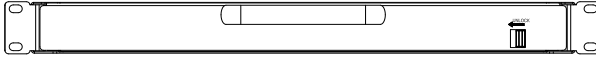

1-2.3 unlocking

***Note: The release catch can only do horizontal locking, it can't bear any load.**

- Pull the KVM console all the way out and the slide rail automatically locked to its place.
- Rotate the LED panel all the way back to expose the LED screen; the LED module can be rotated up to 108°.

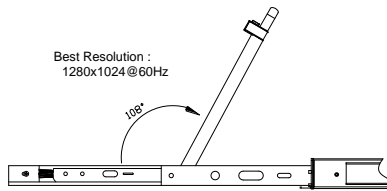

2-1.4 open angle of the console

Closing the Console

- Close the console and the power automatically shut down.
- Push the release catch in the direction of the arrow, push the LED panel all the way in until it automatically lock up.

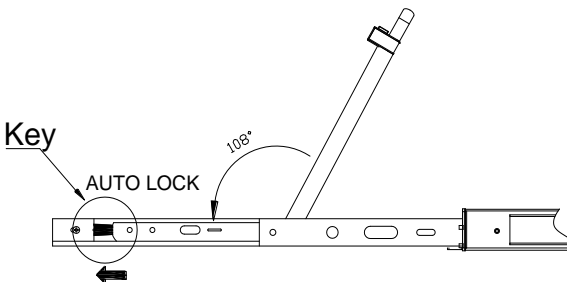

1-2.5 unlocking the slide rail

OSD Controls



1-2.6 OSD controls

Buttons	Functions
MENU SELECT	Press this button invokes the menu function and brings up the main menu.
EXIT/AUTO	Press EXIT exits the current menu and returns to the previous menu or presses this button exits the LED OSD. Press AUTO for automatic configuration.
SL-/SL+	Press this button moves your menu to make corresponding adjustment.
LED state	Green :running Red :power off or access non standard VESA signal Flash green: energy saving mode or no signal

Table 1-2.1 OSD controls instructions

Press AUTO when the screen migrates after power on or under other circumstances, then the screen auto configure to its best display state.(It might can't be adjusted to its best state if part of the display mode is not standard VESA mode, if so return back to OSD menu to RESET, then it will back to normal.

We suggest our customers to set up the display mode at 1280x1024, refresh rate at 60Hz.

Specifications-17"

Model		LS2701
Computer Connections	Direct	1(DB15 female blue)
	Max	1
Port emulation	Keyboard, mouse	PS/2, USB
LED monitor	LED model	XGA TFT
	View area	17"
	Optimum resolution	1280×1024@60Hz
	Display color	16.7 M
	Brightness	250cd/m ² (T y p)
	Contrast ratio	1000 : 1 (T y p)
	Pixel pitch(mm)	0.264(H) × 0.264(W)
Mouse	X/Y resolution	>1000 points / inch,(40 points/mm)
	Scroll wheel	Support scroll wheel function
Keyboard		99 keys (82 keys main keyboard +17 independent small numeric keyboard)
Input power		100V~ 240Vac , 50~60Hz , <1.5A
Power consumption		13W
Operating temperature		0— 50 °C
Store temperature		-20 — 60 °C
Humidity		0~80% RH,non-condensing
Net weight		11.7 kg
Product dimension (W × D × H)		448mm×471mm×42.5mm
Package dimension (W × D × H)		765mm×615mm×185mm
Optional power input		-36V—72V DC (model: LS6701)

Specifications-19"

Model		LS1901
Computer Connections	Direct	1 (DB15 female blue)
	Max	1
Port emulation	Keyboard, mouse	PS/2, USB
LED monitor	LED model	SXGA TFT
	View area	19 "
	Optimum resolution	1280×1024@60Hz
	Display color	16.7 M
	Brightness	250cd/m ² (T y p)
	Contrast ratio	1000 : 1 (T y p)
	Pixel pitch(mm)	0.294(H) × 0.294(W)
Mouse	X/Y resolution	>1000 points / inch, (40 points/mm)
	Scroll wheel	Support scroll wheel function
Keyboard	99 keys (82 keys main keyboard +17 independent small numeric keyboard)	
Input power	100V~ 240Vac , 50~60Hz , <1.5A	
Power consumption	17W	
Operating temperature	0— 50 °C	
Store temperature	-20 — 60 °C	
Humidity	0~80% RH, non-condensing	
Net weight	12.2 kg	
Product dimension (W × D × H)	448mm×494mm×42.5mm	
Package dimension (W × D × H)	765mm×615mm×185mm	
Optional power input	-36V~ -72V DC (model: LS5901)	
Optional power input	20~30VDC (model: LS6901)	