

# Rackmount LCD Console (4 Port) User Manual



[www.kinankvm.com](http://www.kinankvm.com)

@all right reserved Shenzhen Kinan Technology Co., Ltd

Print date: 2022/04

Version: V1.2

## Contents

Overview.....	3
Product Description.....	3
Product Features.....	3
Switch Functions.....	3
Front view.....	4
Structure and Size (19").....	5
Hardware Installation.....	6
Rack Mounting.....	6
Installation instruction.....	7
Opening the console.....	8
LED Instructions.....	9
LED OSD Configuration.....	10
OSD Operation.....	11
OSD Functions.....	12
F1-ADM.....	13
F2-Scan.....	16
F3-Set.....	17
F4-Tool.....	19
F6-Edit port names.....	20
F7-Set quick view port (QV).....	20
F8-LOUT.....	20
USB Keyboard Emulation.....	22
Mac keyboard.....	22
Sun keyboard.....	23
Appendix.....	24
Specifications(19").....	24
Troubleshooting.....	25

## Overview

### Product Description

The KVM console integrates multiple port KVM switches in a 1U height console. It can control multiple computers with one monitor, keyboard and mouse.

It is easy and fast to install the KVM console, you just need to connect corresponding cables to the right ports of KVM and its module without software configuration.

The KVM console can control up to 4 computers, supports multiple hardware platforms and multiple operating systems.

### Product Features

- 19" LED TFT monitor with high resolution.
- 1U height, suitable height for standard 19" rack mount, metal structure.
- Ultra slim 99 keys keyboard with small numeric keyboard.
- High resolution and high flexibility with touchpad with two function buttons and scroll wheel.

### Switch Functions

- A single USB console controls up to 4 computers
- Supports wireless keyboard and mouse from different suppliers
- Two level password security--only authorized users view and control computers; up to four users and an administrator with a separate profile for each
- Users can set up different hot keys( **【Scroll Lock】** / **【Caps Lock】** / **【F12】** / **【Ctrl】** ), auto scanning time, port display time, log out time, buzzer on /off and mouse on/off according to their different needs
- Broadcast mode--operations simultaneously performed on all selected computers
- Multiplatform support--Windows, Linux, Mac and Sun
- Supports multimedia USB keyboard(PC, Mac and Sun)
- USB keyboard emulation--computer boot even the console focus is else where
- Convenient computer switching via front panel pushbuttons, hotkeys, OSD menu
- Automatically shows the computer position on the front panel LED screen under daisy chaining connection without DIP set by hand
- Auto scan feature for monitoring user-selected computers
- Hot pluggable --add or remove computers without having to power down the switch
- Quickly select your computer by naming the server or inputting SN number of the server

Front view

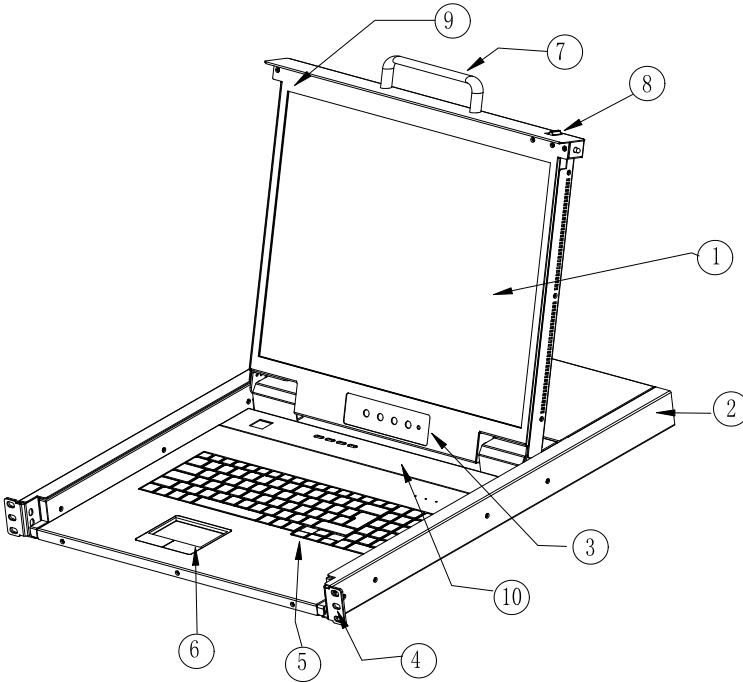

Figure 1-1.1 front view

- |                      |                  |
|----------------------|------------------|
| 1. LED Module        | 6. Touchpad      |
| 2. Rear Bracket Slot | 7. Handle        |
| 3. LED OSD Controls  | 8. Release Catch |
| 4. Front Bracket     | 9. Display panel |
| 5. Keyboard          | 10. Switch LED   |

### Structure and Size (19")

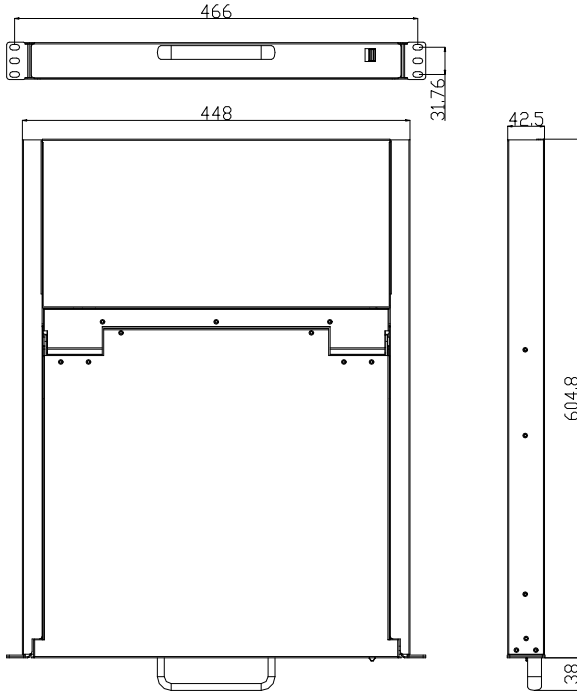

Figure 1-1.2 Appearance

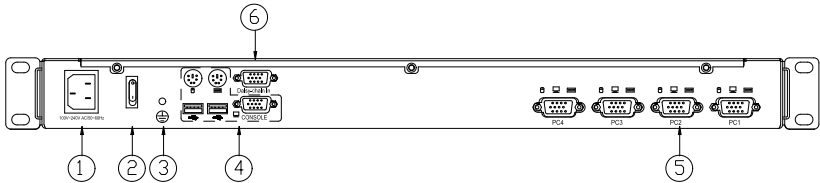

Figure 1-1.3 Rear View

1. Power input (AC)
2. Power switch
3. Ground connection screw
4. Console
5. PC port: 4 port(integrating VGA/keyboard/mouse input port)
6. Cascade port

## Hardware Installation

### Rack Mounting

A standard rack mounting kit is provided to mount the switch in a depth of 716-825mm in a standard 19" rack. For other mounting distance, the rear brackets need to be customized accordingly.

With one person hold the switch in place and the other person slides the L bracket into the switch's side mounting brackets from the front to the back, then screws the brackets to the rack. (See below installation drawing)

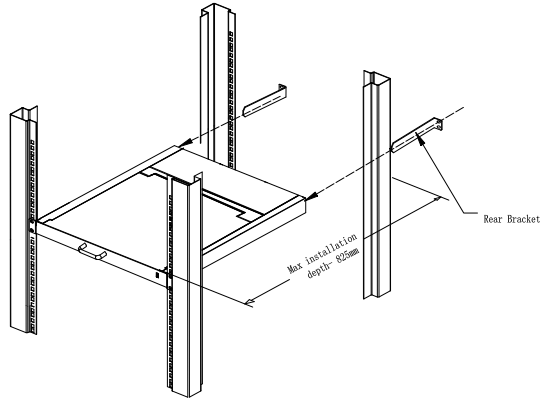

Figure 2-1.1 rack mounting (1)

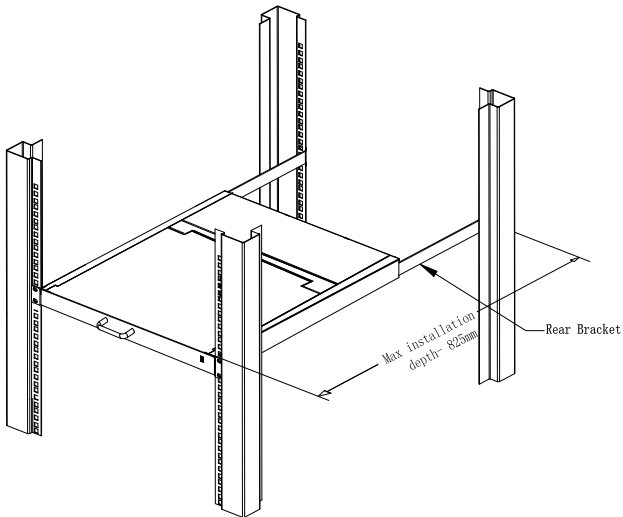

Figure 2-1.2 rack mounting (2)

## Installation instruction

- 1) Make sure the rack mounting KVM switch has been connected to the ground (① in the diagram)
- 2) Connect KVM switch with the computer according to ② in the diagram
- 3) Connect power cable to KVM port as shown in ③ in the diagram
- 4) Turn on the power, the KVM start to work after power supply(④ in the diagram)

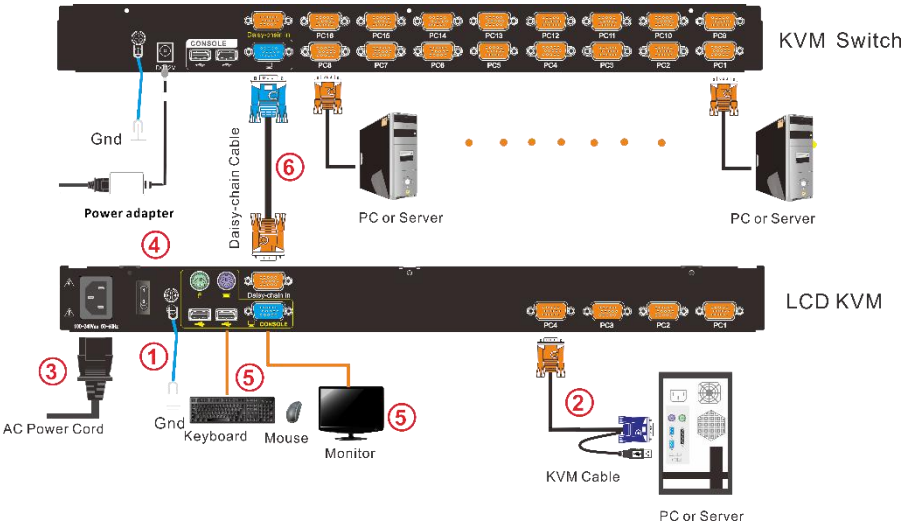

Figure 2-2.1

Note: 1) Connect monitor, USB or PS/2 keyboard and mouse to Console port to connect another console. (⑤ in the diagram)

\*Note: Not supports OSD on external display, to switch via hotkey **【Ctrl】**, see details on page 18 about OSD Hotkey function instructions

- 2) Daisy chaining multiple KVM switches according to ⑥ in the diagram. Plug the yellow port of daisy chaining cable in the yellow “Daisy-Chain in” DB 15 port on LCD KVM console, then plug the other blue port in the blue “Console” DB 15 port on KVM switch, etc.

## Opening the console

- Release the release catch;

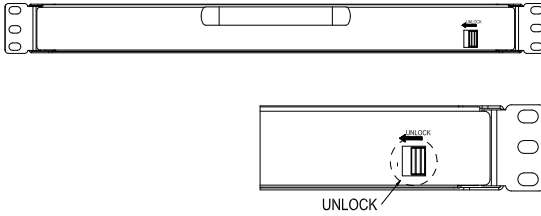

Figure 2-3.1 unlocking

**\*Note:** The release lock can only do horizontal locking, it can't bear any load.

- Pull the LED panel all the way out until it clicks into place.
- Rotate the LED module all the way back to expose the LED screen, the LED module can be rotated up to 108°.

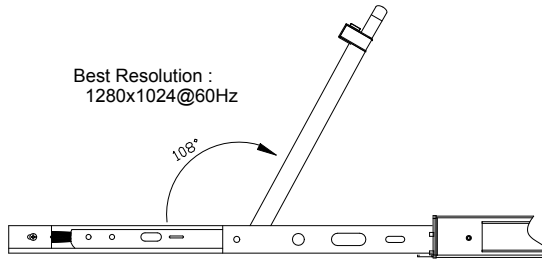

Figure 2-3.2 rotate angle of the console

- Turn on power switch , KVM will beep twice The Port LEDs light flashes 4 times , System will prompt to enter username and password

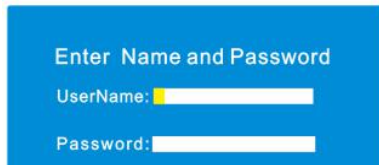

Figure 2-3.3 password window

- LED panel is powered on when the power LED is green.
- Power on computer or server then power on KVM and you will see green light on each port.
- The factory default password is blank, double click "Enter".



### Closing the console

- Close the LED display panel and the power automatically will shut down.
- Push the release catch in the direction of the arrow, push the LED panel all the way in until it automatically lock up.

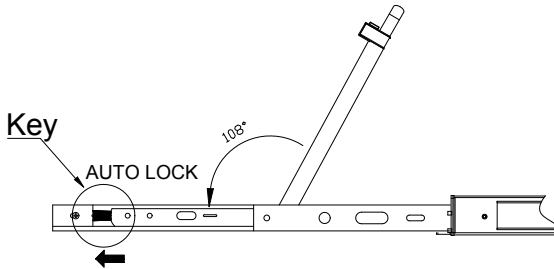

Figure 2-3.4 open angle of the console

### LED Instructions



Figure 3-1.1 front view

No.	Components	Function
1	1-4	1) Switching freely from port 1 to port 4 2) Press <b>【1】</b> and <b>【2】</b> at the same time resets the KVM.
2	Port Selection Buttons& LEDs	Indicator LEDs are built into the switches, the online LED light is on the left and the selected LED light is on the right. 1) An online LED light(green) indicates that the KVM has connected to its corresponding computer and power on. 2) A selected LED light(orange) indicates that the computer attached to its corresponding port is up and running.
3	Station ID	Display the current port

Table 1.1 LED instructions

## LED OSD Configuration



The LED OSD allows you to set up and configure the LED display.

Buttons	Functions
MENU SELECT	Opens the menu function and brings up the main menu.
EXIT/AUTO	Press this button exits the current menu and return to the previous menu or press this button exits the LED OSD. Press AUTO for automatic configuration.
SL-/SL+	moves your menu to make corresponding adjustment.
LED state	Green :running Red :power off or access nonstandard VESA signal Flash green: energy saving mode or no signal

Table 1.2 LED OSD configuration instruction

Press AUTO if the screen migrates after power on or under other circumstances, then the screen auto configure to its best display state.(It might can't be adjusted to its best state if part of the display mode is not standard VESA mode, if so return back to OSD menu to RESET, then it will back to normal.

We suggest our customers to set up the display mode at 1280x1024, refresh rate at 60Hz.

### OSD Operation

Double click the right buttons of the mouse or double click hotkey **【 Scroll Lock 】** to invoke below OSD main menu. You can customize the OSD hotkeys, find more details in OSD function instructions.



Headings	Explanation
SN	level number-port number
⇒	It shows the computer port is under monitoring.
\$	The computers are power on and are online
QV	"#": quick view the port "BC": Broadcast port
LK	"@" shows that the port is only available for viewing
Name	Port name, the maximum is 12 bytes

able 1.3: OSD interface

To access the OSD menu through keyboard:

1. In the submenus that appear, moving the highlight bar to your selected port and then press Enter.
2. Press **【Page Up】** or **【Page Down】** quickly moves to next BANK
3. Press any key from **【0-9】** to enter any port of current station, type Bank+Port to enter other stations.

To access the OSD menu through keyboard:

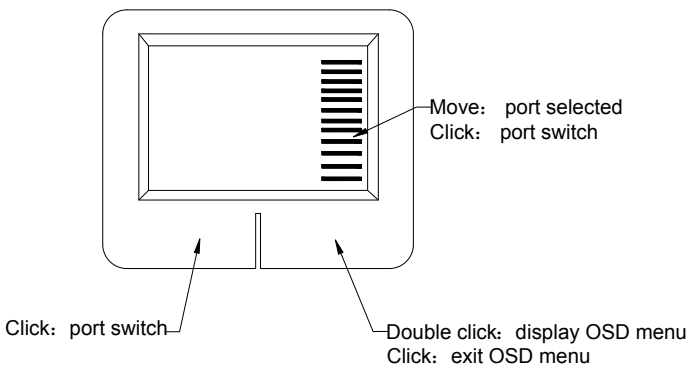

\*Note: Operate via keyboard after invoke the OSD menu via the touchpad.

## OSD Functions

Menus	Keys	Submenu/explanation
ADM	F1	Set User login: account and password Set accessible: Set access permissions BRC Mode: monitor multiple computers at the same time Load Default: reset the menu to the original factory default settings
Scan	F2	All: Lists all the ports on the installation Power On: lists only powered on ports that have attached computers. Quick View: Lists only the ports that have been selected as Quick View ports
Set	F3	Auto Scan: set scanning time period Port ID: set how long a port displays on the monitor OSD Hotkey: set OSD hotkeys Lout Time off: to set the time out value
Tool	F4	Reset KM: press Enter resets keyboard and touchpad Beeper <b>【On】</b> : press Enter switch Bee sounds Mouse Hot <b>【On】</b> : press Enter to shut down touchpad operating on OSD. Restore Values: press Enter restore the current user default value. About KVM: press Enter shows the KVM version
Edit	F6	Edits port names
QV	F7	Start or close Quick View
Lout	F8	Log out/blank the console screen
Exit	Esc	Press this key exits OSD menu
	Scroll Lock	Press this key exits OSD menu
	Num Lock	Press this key exits OSD menu

Table 1.4

**F1-ADM**

● **Menu overview**

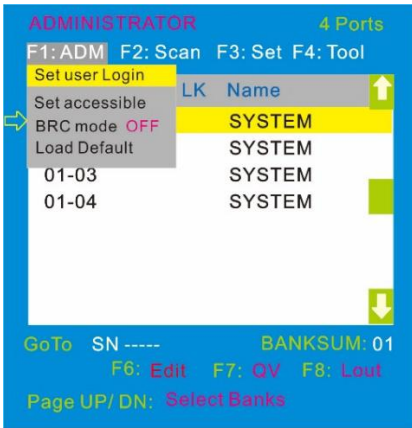

Operating instructions

- 1) Press **[F1]** or **[←]** **[→]** enters the F1 submenus.
- 2) Press **[↑]** **[↓]** moves the highlight bar to select the submenu.
- 3) Press **[Enter]** selects and exits ADM menu.
- 4) Press **[Esc]** cancels the operation and exits ADM menu.

● **Menu explanation**

1. Set User Login—Press **[Enter]** and select Set User Login, a screen as below  
Diagram 4-1.1 appears:

One administrator and four users account can be set (the account and the password are no more than 16 characters)



4-1.1



4-1.2

Note: You can set up an account and password according to diagram 4-1.2, then a “ User setup ok” pops up showing you have done your set, and “Password Not Match” pops up, you need to type in your password again as you did in your first type.

2. Set accessible—press **【Enter】** and select Set Access Permission, then below menu appears: (diagram 4-1.3):



4-1.3

Menu	Explanation
FULL	Full access function to the station and can do any operation to the ports
VIEW	View only function, you can only view the port but you can't operate it if set this function.
NULL	If you set this function, the port will be not displayed on the user's OSD menu

Note: The administrator always has full access to all the ports.

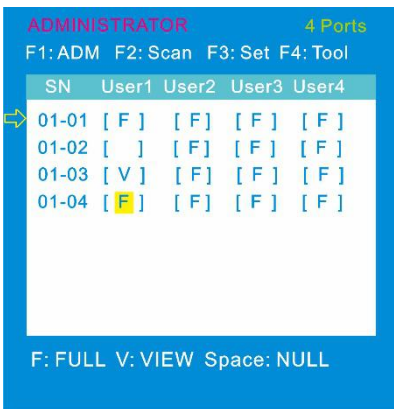

4-1.4

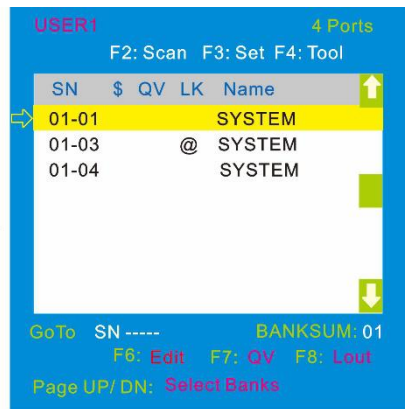

4-1.5

Fig.:1). If you want to set access permission of [User1], press **【Space】** to choose the permission options you need to set.

2). [User1] log in OSD menu, as shown in diagram 4-1.5.

3.BRC Mode - Press **【Enter】** to enter the BRC mode. Enter the main menu, press **【F7】** to add or remove a port that need broadcast function. When BRC mode is effect, a speaker symbol appears in QV column.(see below diagrams).

While BRC mode is in effect, we can operate multiple computer ports simultaneously, but the mouse is not function normally.



4-1.6

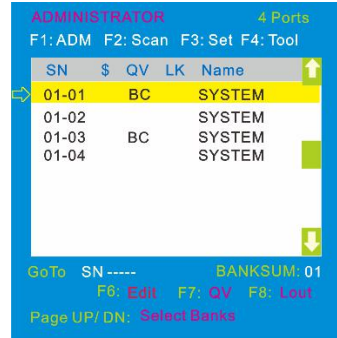

4-1.7

- 1) Open BRC mode  
**【F1】** ->BRC Mode OFF->press **【Enter】** -> BRC Mode ON (see diagram 4-1.6)
- 2) Open the port that need broadcast function  
 Press **【↑】** **【↓】** key—>select the port that need broadcast function →press **【F7】** → a “BC” symbol appears in the QV column which shows the port has entered broadcast mode.
- 3) Close the broadcasting port  
 Press **【↑】** **【↓】** key—>select the port →press **【F7】** →exit BRC mode and the “BC” symbol disappears
- 4) Exit BRC mode  
 Invoke OSD main menu → **【F1】** ->BRC Mode ON ->press **【Enter】** --> BRC Mode OFF, the KVM exits BRC mode(diagram 4-1.8)

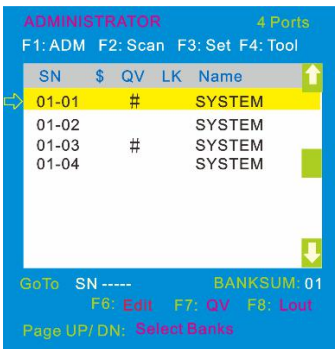

4-1.8



Press **【F1】** ->BRC Mode OFF ->press **【Enter】** ,enter the main menu, all “#” symbols turn into “BC” symbol(diagram 4-1.7)

4. Load Default--- press **【Enter】** and select Load Default, all the set values are restore to original factory default settings.

## F2-Scan

### ● Menu overview



#### Operating instructions

- 1) Press **【F2】** or **【←】** **【→】** enters the F2 submenu.
- 2) Press **【↑】** **【↓】** moves the highlight bar to select the submenu.
- 3) Press **【Enter】** selects and exits Scan menu.
- 4) Press **【Esc】** cancels the operation and exits SCAN menu.

### ● Menu explanation

Submenu	Explanation
All	Use this function to scan all ports according to the set scanning interval.
Power On	Use this function to scan all ports with "\$" according to the set scanning interval.
Quick View	Use this function to scan all ports with "#" quick view symbols according to the set scanning interval.



**F3-Set**

● **Menu overview**



Operating instructions

- 1) Press **【F3】** or **【←】** **【→】** enters the F3 submenu.
- 2) Press **【↑】** **【↓】** moves the highlight bar to select the submenu.
- 3) Press **【Enter】** selects and exits Set menu.
- 4) Press **【Esc】** cancels the operation and exits Set menu.

● **Menu explanation**

Submenu	Default value
Auto Scan	5S (effective range 5-99)
Port ID	0S: not display the port ID 1-98S: display the seconds, maximum 98s 99S: permanent display
OSD Hotkey	<b>【Scroll Lock】 + 【Scroll Lock】</b> <b>【Caps Lock】 + 【Caps Lock】</b> <b>【F12】 + 【F12】</b> <b>【Ctrl】 + 【Ctrl】 + 【KVM Hotkey】</b>
Lout Time off	0: close the screen saver setting 01-99M: set the screen saver timeout Note: It is automatically log out if the current operator is no longer operate for a while, then the KVM will be locked and you need to enter user name and password to operate again:

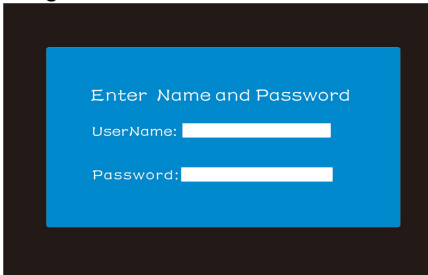

## OSD Hotkey Operation

### Operating instruction

1. Press **【F3】** and move the highlight bar with **【↓】** to select “OSD Hotkey” submenu . Press **【Enter】** and below screen appears:
2. KVM default hotkev: **【Scroll Lock】**

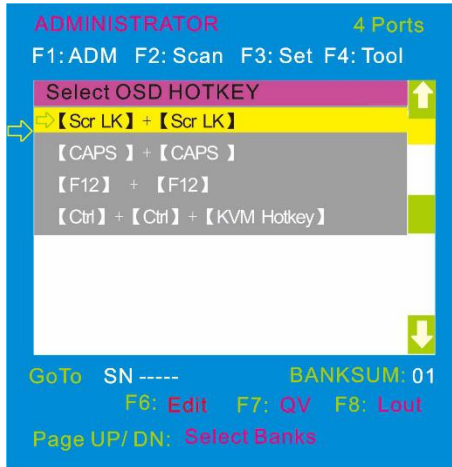

2. Select the “ **【Ctrl】 【Ctrl】 + 【KVM Hotkey】** ” and press **【Enter】** , and then the **【Ctrl】** hotkey is available in this hotkey mode, the mouse hotkey can't enter the OSD menu

Invoke hotkey: double click **【L\_Ctrl】** + the corresponding function key

Function	Operating	Function description
Switching port	+ 1~4	Skip ports from 1~4, Eg.: Double click <b>【L_Ctrl】</b> plus 2 to skip to the second port of the current station.
	+ ↑ / ↓	Skip to previous/next port
Auto scanning	+ S	1.Auto Scan automatically scan ports that attached PC or server. Users can set the scan duration in OSD menu and press any key to exit scanning mode. 2.Move the mouse to extend scan interval.
Invoke OSD main menu	+ “space” key	This allows you to invoke OSD main menu ( see OSD menu operation )

**F4-Tool**

● **Menu overview**



Operating instructions

- 1) Press **【F4】** or **【←】** **【→】** enters the F4 submenus.
- 2) Press **【↑】** **【↓】** moves the highlight bar to select the submenu.
- 3) Press **【Enter】** selects and exits Tool menu.
- 4) Press **【Esc】** cancels the operation and exits Tool menu.

● **Menu explanation**

Submenu	Instruction
Reset KM	Initialize the keyboard and mouse that connected to KVM when they are break down.
Beeper <b>【On】</b>	The beeper can be turned on or off with this function.
Mouse Hot <b>【On】</b>	To open and close the mouse with this function. We can't operate the OSD when it is <b>【Off】</b> .
Restore Values	Restore to original factory default values.
About KVM	It shows the KVM version information.

## F6-Edit port names

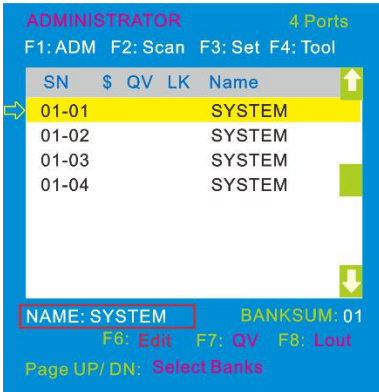

- Select the port with 【↑】 【↓】 key;
- Press F6 and key in the new name or modify the old one, then press Enter to save the name and exit editing.
- Press 【Esc】 to cancel and exit the editing.

Note:

The NAME characters include:

All alpha characters: A-Z

All numeric characters: 0-9

Default value: SYSTEM

## F7-Set quick view port (QV)



- Select ports with 【↑】 【↓】 keys;
- Press 【F7】 to include current port as Quick View, then an arrowhead appears in the QV column to indicate so.

Note:

Press 【F7】 to cancel the QV symbol is the current port has already have a QV arrowhead symbol in its QV column; if you want to cancel all the QV function, press Restore Values under F4: Tool. (The port name restores to default setting at the same time.)

## F8-LOUT

- Press 【F8】 exits the OSD main menu and fully exits current port, then the log in window appears:

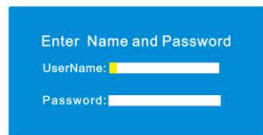

- Users must log in all over again to regain access to the OSD.

## Setting OSD default values

Settings	Default values
OSD hotkey	【 Scroll Lock 】 【 Scroll Lock 】
Original user name	【 Enter 】
Original password	【 Enter 】
Port display duration	0 seconds
Port display mode	Bank No.+ Port No.+ port name
Port name	SYSTEM
Scan duration	5 seconds
Scan mode	All
Auto log out	【 Esc 】

## Operating system







### Support operating system:

Operating system	Version	
Windows	2000 or higher	
Linux	RedHat	6.0 or higher
	SuSE	8.2 or higher
	Mandriva(Mandrake)	9.0 or higher
UNIX	AIX	4.3 or higher
	FreeBSD	3.51 or higher
	Sun	Solais8 or higher
Nove11	Netware	5.0 or higher
Mac		8.6 or higher
DOS		6.2 or higher

## USB Keyboard Emulation









### Mac keyboard

The PC compatible (101/104 keys) keyboard can emulate the functions of the Mac keyboard. The emulation mappings are listed in the below table:

PC keyboard	MAC keyboard
[Shift]	Shift
[Ctrl]	Ctrl
	
L_Win & "1"	
L_Win & "2"	
L_Win & "3"	
L_Win & F12	
[Alt]	Alt
[Print Screen]	F13
[Scroll Lock]	F14
	=
[Enter]	Return
[Backspace]	Delete
[Insert]	Help

## Sun keyboard

The PC compatible (101/104 keys) keyboard can emulate the functions of the Sun keyboard when the control key [L\_Win] is used in conjunction with other keys. The corresponding functions are shown in the below table:

PC keyboard	Sun keyboard
L_Win&L_Alt	Stop
L_Win&F4	Again
L_Win&L_Ctrl	Props
L_Win&F5	Undo
L_Win&F1	Front
L_Win&F6	Copy
L_Win&F2	Open
L_Win&F7	Paste
L_Win&F3	Find
L_Win&F8	Cut
L_Win&"1"	V_DN  
L_Win&"2"	Mute  
L_Win&"3"	V_UP  
L_Win&F12	Power 
L_Win&F11	Help
L_Win&L_Shift	Compose
	◆

## Appendix

### Specifications(19")

Function		Model No	XL1904
Computer connections	Direct		4
	Max		128
Port emulation	Keyboard, mouse		USB
LED monitor	LED model		SXGA TFT
	View area		19"
	Optimum resolution		1280×1024@60Hz
	Display color		16.7 M
	Brightness		250cd/m <sup>2</sup> ( T y p )
	Contrast ratio		1000 : 1 ( T y p )
	Pixel pitch(mm)		0.2928(H) × 0.2928(W)
Mouse	X/Y resolution		>1000 points /inch,( 40 points/mm )
	Roll wheel		Supports scroll wheel function
Keyboard			99 keys (82 keys main keyboard +17 independent small numeric keyboard)
Port selection			Front panel pushbuttons, hotkeys, OSD menu
Input power			100V- 240Vac , 50-60Hz , <1.5A
Power consumption			20W
Operating temperature			0—50 °C
Store temperature			-20—60 °C
Humidity			0—80% RH, non-condensing
Net weight			13.2kg
Product dimension (W × D × H)			448mm×605mm×42.5mm
Package dimension (W × D × H)			765mm×615mm×185mm



## Troubleshooting

1. The KVM console does not work when I connect and use the console for the first time.

Solutions:

Please re-connect the KVM console according to below steps:

- 1) Disconnect all the signal and power cables connected to KVM.
- 2) Then power on KVM and you hear the boot indicating sound from the beeper, a screen automatically pop up for you to enter the user name and password.
- 3) Type in the correct user name and password, the original password is clicking Enter twice, then the OSD main menu pop up on the screen.
- 4) Check the KVM console and make sure it can normally switch ports .
- 5) Connect one server(PC) to one of the KVM ports with signal cable and check port switching function, check the keyboard and mouse, if they are not working, try to re-start the server(PC).
- 6) After successfully finishing all above steps, gradually add server(PC) to this console until meet your need.

2. There is no pop up window to type in user name and password or the pop up window is not normally displayed.

Solutions:

- 1) Check the AC/DC output.
- 2) Make sure you have heard the indicating sound and the keyboard LED is on after starting up the computer.
- 3) Check the LED power and make sure the LED signal cable has connected to the KVM console.

3. I can't log in the KVM system after starting computer.

Solutions:

- 1) Make sure the KVM keyboard is working, the user name and password is correct. The default value is blank, you can log in after press Enter.
- 2) If you still can't log in the system, try to connect an external USB or PS/2 keyboard.( The original default value is blank, you can log in after double clicking Enter )

4. I can't switch from one port to another after logging in the KVM system.

Solutions:

- 1) Invoke the OSD main menu and check the user name on the top left, make sure the user has got the access permission from the administrator.
- 2) Please contact the distributor or the KVM manufacturer.

5. Bad display quality of PC screen.

Solutions:

- 1) Check the signal cables, make sure they are connected.
- 2) Reset the monitor's display settings.

6. When I switch to one port, the keyboard and mouse do not work.

Solutions:

- 1) Make sure you have exited the OSD menu.
- 2) Invoke the OSD main menu and check the user name on the top left, make sure the user has got the access permission from the administrator.
- 3) Pull out the USB port of the server (PC) then plug in.
- 4) If you connected the PC with PS/2 port, try to re-start the server (PC).

7. I can't invoke the OSD main menu.

Solutions:

- 1) Check the keyboard to make sure it is working.
- 2) Double click **【Scroll\_Lock】** .
- 3) Double click **【F12】**
- 4) Double click **【Caps Lock】**
- 5) Double click **【Ctrl】 + 【Space】**

8. The OSD code is in disorder or abnormal displayed when daisy chaining.

Solution:

Invoke the OSD menu after daisy chaining, Press **【F1】** and choose **【Load default】**, then press enter to refresh OSD ROM.